

WORKSHOP CALCULATION & SCIENCE

(NSQF)

1st YEAR

(As per Revised Syllabus July 2022)

Central Air Condition Plant Mechanic



Directorate General of Training

DIRECTORATE GENERAL OF TRAINING
MINISTRY OF SKILL DEVELOPMENT & ENTREPRENEURSHIP
GOVERNMENT OF INDIA



**NATIONAL INSTRUCTIONAL
MEDIA INSTITUTE, CHENNAI**

Post Box No. 3142, CTI Campus, Guindy, Chennai - 600 032

Workshop Calculation & Science

Central Air Condition Plant Mechanic - 1st Year NSQF

As per Revised Syllabus July 2022

Developed & Published by



National Instructional Media Institute

Post Box No.3142

Guindy, Chennai - 600032

INDIA

Email: chennai-nimi@nic.in

Website: www.nimi.gov.in

Copyright © 2023 National Instructional Media Institute, Chennai

First Edition : January 2023

Copies: 1000

Rs:/-

All rights reserved.

No part of this publication can be reproduced or transmitted in any form or by any means, electronic or mechanical, including photocopy, recording or any information storage and retrieval system, without permission in writing from the National Instructional Media Institute, Chennai.

FOREWORD

The Government of India has set an ambitious target of imparting skills one out of every four Indians, to help them secure jobs as part of the National Skills Development Policy. Industrial Training Institutes (ITIs) play a vital role in this process especially in terms of providing skilled manpower. Keeping this in mind, and for providing the current industry relevant skill training to Trainees, ITI syllabus has been recently updated with the help of comprising various stakeholder's viz. Industries, Entrepreneurs, Academicians and representatives from ITIs.

The National Instructional Media Institute (NIMI), Chennai, has now come up with instructional material to suit the revised curriculum for **Workshop Calculation & Science - Central Air Condition Plant Mechanic 1st Year** NSQF (Revised 2022) under CTS will help the trainees to get an international equivalency standard where their skill proficiency and competency will be duly recognized across the globe and this will also increase the scope of recognition of prior learning. NSQF trainees will also get the opportunities to promote life long learning and skill development. I have no doubt that with NSQF the trainers and trainees of ITIs, and all stakeholders will derive maximum benefits from these IMPs and that NIMI's effort will go a long way in improving the quality of Vocational training in the country.

The Executive Director & Staff of NIMI and members of Media Development Committee deserve appreciation for their contribution in bringing out this publication.

Jai Hind

New Delhi - 110 001

Ms. TRISHALJIT SETHI,
Additional Secretary / Director General (Training),
Ministry of Skill Development & Entrepreneurship,
Government of India.

PREFACE

The National Instructional Media Institute(NIMI) was set up at Chennai, by the Directorate General of Training, Ministry of skill Development and Entrepreneurship, Government of India, with the technical assistance from the Govt of the Federal Republic of Germany with the prime objective of developing and disseminating instructional Material for various trades as per prescribed syllabus and Craftsman Training Programme(CTS) under NSQF levels.

The Instructional materials are developed and produced in the form of Instructional Media Packages (IMPs), consisting of Trade Theory, Trade Practical, Test and Assignment Book, Instructor Guide. The above material will enable to achieve overall improvement in the standard of training in ITIs.

A national multi-skill programme called SKILL INDIA, was launched by the Government of India, through a Gazette Notification from the Ministry of Finance (Dept of Economic Affairs), Govt of India, dated 27th December 2013, with a view to create opportunities, space and scope for the development of talents of Indian Youth, and to develop those sectors under Skill Development.

The emphasis is to skill the Youth in such a manner to enable them to get employment and also improve Entrepreneurship by providing training, support and guidance for all occupation that were of traditional types. The training programme would be in the lines of International level, so that youths of our Country can get employed within the Country or Overseas employment. The **National Skill Qualification Framework (NSQF)**, anchored at the National Skill Development Agency(NSDA), is a Nationally Integrated Education and competency-based framework, to organize all qualifications according to a series of **levels of Knowledge, Skill and Aptitude**. Under NSQF the learner can acquire the Certification for Competency needed at any level through formal, non-formal or informal learning.

The **Workshop Calculation & Science - Central Air Condition Plant Mechanic 1st Year NSQF (Revised 2022)** under CTS is one of the book developed by the core group members as per the NSQF syllabus.

The **Workshop Calculation & Science - Central Air Condition Plant Mechanic 1st Year NSQF (Revised 2022)** under CTS as per NSQF is the outcome of the collective efforts of experts from Field Institutes of DGT, Champion ITI's for each of the Sectors, and also Media Development Committee (**MDC**) members and Staff of **NIMI**. NIMI wishes that the above material will fulfill to satisfy the long needs of the trainees and instructors and shall help the trainees for their Employability in Vocational Training.

NIMI would like to take this opportunity to convey sincere thanks to all the Members and Media Development Committee (MDC) members.

Chennai - 600 032

EXECUTIVE DIRECTOR

ACKNOWLEDGEMENT

The National Instructional Media Institute (NIMI) sincerely acknowledge with thanks the co-operation and contribution of the following Media Developers to bring this IMP for the course **Workshop Calculation & Science - Central Air Condition Plant Mechanic 1st Year** as per NSQF Revised 2022.

MEDIA DEVELOPMENT COMMITTEE MEMBERS

Shri. M. Sangara pandian	-	Training Officer (Retd.) CTI, Govt. of India, Guindy, Chennai - 32.
Shri. G. Sathiamoorthy	-	Jr. Training Officer - SG (Retd.) Govt I.T.I, Trichy, DET - Tamilnadu.

NIMI CO-ORDINATORS

Shri. Nirmalya Nath	-	Deputy General Manager, NIMI, Chennai - 32.
Shri. G. Michael Johny	-	Manager, NIMI, Chennai - 32.

NIMI records its appreciation of the **Data Entry, CAD, DTP Operators** for their excellent and devoted services in the process of development of this IMP.

NIMI also acknowledges with thanks, the efforts rendered by all other staff who have contributed for the development of this book.

INTRODUCTION

The material has been divided into independent learning units, each consisting of a summary of the topic and an assignment part. The summary explains in a clear and easily understandable fashion the essence of the mathematical and scientific principles. This must not be treated as a replacement for the instructor's explanatory information to be imparted to the trainees in the classroom, which certainly will be more elaborate. The book should enable the trainees in grasping the essentials from the elaboration made by the instructor and will help them to solve independently the assignments of the respective chapters. It will also help them to solve the various problems, they may come across on the shop floor while doing their practical exercises.

The assignments are presented through 'Graphics' to ensure communications amongst the trainees. It also assists the trainees to determine the right approach to solve the problems. The required relevant data to solve the problems are provided adjacent to the graphics either by means of symbols or by means of words. The description of the symbols indicated in the problems has its reference in the relevant summaries.

At the end of the exercise wherever necessary assignments, problems are included for further practice.

Time allotment:

Duration of 1st Year : 40 Hrs

Time allotment for each title of exercises has been given below. **Workshop Calculation & Science - Central Air Condition Plant Mechanic 1st Year NSQF Revised Syllabus 2022.**

S.No	Title	Exercise No.	Time in Hrs
1	Unit, Fractions	1.1.01 - 1.1.07	4
2	Square root, Ratio and Proportions, Percentage	1.2.08 - 1.2.14	6
3	Material Science	1.3.15 - 1.3.19	6
4	Mass, Weight, Volume and Density	1.4.20 & 1.4.21	2
5	Speed and Velocity, Work, Power and Energy	1.5.22	2
6	Heat & Temperature and Pressure	1.6.23 - 1.6.29	12
7	Basic Electricity	1.7.30 - 1.7.33	4
8	Mensuration	1.8.34 & 1.8.35	4
Total			40 Hrs

LEARNING / ASSESSABLE OUTCOME

On completion of this book you shall be able to

- **Demonstrate basic mathematical concept and principles to perform practical operations.**
- **Understand and explain basic science in the field of study.**

CONTENTS

Exercise No.	Title of the Exercise	Page No.
	Unit, Fractions	
1.1.01	Unit, Fractions - Classification of unit system	1
1.1.02	Unit, Fractions - Fundamental and Derived units F.P.S, C.G.S, M.K.S and SI units	2
1.1.03	Unit, Fractions - Measurement units and conversion	3
1.1.04	Unit, Fractions - Factors, HCF, LCM and problems	8
1.1.05	Unit, Fractions - Fractions - Addition, subtraction, multiplication & division	9
1.1.06	Unit, Fractions - Decimal fractions - Addition, subtraction, multiplication & division	12
1.1.07	Unit, Fractions - Solving problems by using calculator	15
	Square root, Ratio and Proportions, Percentage	
1.2.08	Square root, Ratio and Proportions, Percentage - Square and square root	19
1.2.09	Square root, Ratio and Proportions, Percentage - Simple problems using calculator	20
1.2.10	Square root, Ratio and Proportions, Percentage - Applications of pythagoras theorem and related problems	21
1.2.11	Square root, Ratio and Proportions, Percentage - Ratio and proportion	23
1.2.12	Square root, Ratio and Proportions, Percentage - Ratio and proportion - Direct and indirect proportions	25
1.2.13	Square root, Ratio and Proportions, Percentage - Percentage	28
1.2.14	Square root, Ratio and Proportions, Percentage - Changing percentage to decimal and fraction	30
	Material Science	
1.3.15	Material science - Types of metals, types of ferrous and non ferrous metals	31
1.3.16	Material science - Physical and mechanical properties of metals	33
1.3.17	Material science - Introduction of iron and cast iron	36
1.3.18	Material science - Difference between iron & steel, alloy steel and carbon steel	39
1.3.19	Material science - Properties and uses of insulating materials	41
	Mass, Weight, Volume and Density	
1.4.20	Mass, Weight, Volume and Density - Mass, volume, density, weight and specific gravity	42
1.4.21	Mass, Weight, Volume and Density - Related problems for mass, volume, density, weight and specific gravity	44
	Speed and Velocity, Work, Power and Energy	
1.5.22	Speed and Velocity, Work, Power and Energy - Work, power, energy, HP, IHP, BHP and efficiency	48

Exercise No.	Title of the Exercise	Page No.
Heat & Temperature and Pressure		
1.6.23	Heat & Temperature and Pressure - Concept of heat and temperature, effects of heat, difference between heat and temperature, boiling point & melting point of different metals and non-metals	54
1.6.24	Heat & Temperature and Pressure - Scales of temperature, celsius, fahrenheit, kelvin and conversion between scales of temperature	56
1.6.25	Heat & Temperature and Pressure - Temperature measuring instruments, types of thermometer, pyrometer and transmission of heat - Conduction, convection and radiation	58
1.6.26	Heat & Temperature and Pressure - Co-efficient of linear expansion and related problems with assignments	60
1.6.27	Heat & Temperature and Pressure - Problem of heat loss and heat gain with assignments	62
1.6.28	Heat & Temperature and Pressure - Thermal conductivity and insulators	65
1.6.29	Heat & Temperature and Pressure - Concept of pressure - Units of pressure, atmospheric pressure, absolute pressure, gauge pressure and gauges used for measuring pressure	67
Basic Electricity		
1.7.30	Basic electricity - Introduction and uses of electricity, electric current AC,DC their comparison, voltage, resistance and their units	74
1.7.31	Basic electricity - Conductor, insulator, types of connections - series and parallel	77
1.7.32	Basic electricity - Ohm's law, relation between V.I.R & related problems	82
1.7.33	Basic electricity - Electrical power, energy and their units, calculation with assignments	84
Mensuration		
1.8.34	Mensuration - Area and perimeter of square, rectangle and parallelogram	87
1.8.35	Mensuration - Area and perimeter of triangles	91

SYLLABUS

1st Year

Workshop Calculation & Science - Central Air Condition Plant Mechanic Revised syllabus July 2022 under CTS

S.No.	Title	Time in Hrs
I	Unit, Fractions 1 Classification of Unit System 2 Fundamental and Derived Units F.P.S, C.G.S, M.K.S and SI Units 3 Measurement Units and Conversion 4 Factors, HCF, LCM and Problems 5 Fractions – Addition, Subtraction, Multiplication & Division 6 Decimal Fractions – Addition, Subtraction, Multiplication & Division 7 Solving Problems by using calculator	4
II	Square root, Ratio and Proportions, Percentage 1 Square and Square root 2 Simple problems using calculator 3 Applications of Pythagoras theorem and related problems 4 Ratio and Proportion 5 Ratio and Proportion - Direct and Indirect proportions 6 Percentage 7 Percentage - Changing percentage to decimal and fraction	6
III	Material Science 1 Types of metal, types of ferrous and non ferrous metals 2 Physical and Mechanical Properties of metals 3 Introduction of iron and cast iron 4 Difference between iron & steel, alloy steel and carbon steel 5 Properties and uses of insulating materials	6
IV	Mass, Weight, Volume and Density 1 Mass, volume, density, weight and specific gravity 2 Related problems for mass, volume, density, weight and specific gravity	2
V	Speed and Velocity, Work, Power and Energy 1 Work, power, energy, HP, IHP, BHP and efficiency	2

S.No.	Title	Time in Hrs
VI	<p>Heat & Temperature and Pressure</p> <ol style="list-style-type: none"> 1 Concept of heat and temperature, effects of heat, difference between heat and temperature, boiling point & melting point of different metals and non-metals 2 Scales of temperature, Celsius, Fahrenheit, Kelvin and Conversion between scales of temperature 3 Temperature measuring instruments, types of thermometer, pyrometer and transmission of heat - Conduction, convection and radiation 4 Co-efficient of linear expansion and related problems with assignments 5 Problem of Heat loss and heat gain with assignments 6 Thermal conductivity and insulators 7 Concept of pressure - Units of pressure, atmospheric pressure, absolute pressure, gauge pressure and gauges used for measuring pressure 	12
VII	<p>Basic Electricity</p> <ol style="list-style-type: none"> 1 Introduction and uses of electricity, electric current AC, DC their comparison, voltage, resistance and their units 2 Conductor, Insulator, types of connections- Series and Parallel 3 Ohm's Law, relation between VIR & related problems 4 Electrical power, energy and their units, calculation with assignments 	4
VIII	<p>Mensuration</p> <ol style="list-style-type: none"> 1 Area and perimeter of square, rectangle and parallelogram 2 Area and Perimeter of triangles 	4
	Total	40

Unit, Fractions - Classification of unit system

Necessity

All physical quantities are to be measured in terms of standard quantities.

Unit

A unit is defined as a standard or fixed quantity of one kind used to measure other quantities of the same kind.

Classification

Fundamental units and derived units are the two classifications.

Fundamental units

Units of basic quantities of length, mass and time.

Derived units

Units which are derived from basic units and bear a constant relationship with the fundamental units. E.g. area, volume, pressure, force etc.

Systems of units

- F.P.S system is the British system in which the basic units of length, mass and time are foot, pound and second respectively.
- C.G.S system is the metric system in which the basic units of length, mass and time are centimeter, gram and seconds respectively.
- M.K.S system is another metric system in which the basic units of length, mass and time are metre, kilogram and second respectively.
- S.I. units are referred to as Systems International units which is again of metric and the basic units, their names and symbols are as follows.

Fundamental units and derived units are the two classifications of units.

Length, mass and time are the fundamental units in all the systems (i.e) F.P.S, C.G.S, M.K.S and S.I. systems.

Example

Length: What is the length of copper wire in the roll, if the roll of copper wire weighs 8kg, the dia of wire is 0.9cm and the density is 8.9 gm/cm³?

Solution

mass of copper wire in the roll = 8kg (or) 8000grams

Dia of copper wire in the roll = 0.9cm

Density of copper wire = 8.9 gm/cm³

Area of cross section of copper wire

$$= \frac{\pi d^2}{4} = \frac{\pi \times (0.9^2)}{4} = 0.636\text{cm}^2$$

Volume of copper wire

$$= \frac{\text{Mass of copper wire}}{\text{Density of copper wire}} = \frac{8000\text{grams}}{8.9 \text{ gm/cm}^3} = 898.88\text{cm}^3$$

Length of copper wire

$$= \frac{\text{Volume of copper wire}}{\text{Area of cross section of copper wire}} = \frac{898.88\text{cm}^3}{0.636\text{cm}^2} = 1413.33 \text{ cm}$$

Length of copper wire = 1413cm.

Time: The S.I. unit of time, the second, is another base units of S.I., it is defined as the time interval occupied by a number of cycles of radiation from the calcium atom. The second is the same quantity in the S.I. in the British and in the U.S. systems of units.

Fundamental units of F.P.S, C.G.S, M.K.S and S.I

S.No.	Basic quantity	British units		Metric units				International units	
		F.P.S	Symbol	C.G.S	Symbol	M.K.S	Symbol	S.I Units	Symbol
1	Length	Foot	ft	Centimetre	cm	Metre	m	Metre	m
2	Mass	Pound	lb	Gram	g	Kilogram	kg	Kilogram	Kg
3	Time	Second	s	Second	s	Second	s	Second	s
4	Current	Ampere	A	Ampere	A	Ampere	A	Ampere	A
5	Temperature	Fahrenheit	°F	Centigrade	°C	Centigrade	°C	Kelvin	K
6	Light intensity	Candela	Cd	Candela	Cd	Candela	Cd	Candela	Cd

Unit, Fractions - Fundamental and Derived units F.P.S, C.G.S, M.K.S and SI units

Derived units of F.P.S, C.G.S, M.K.S and SI system

S.No	Physical quantity	British units		Metric units				International units	
		FPS	Symbol	CGS	Symbol	MKS	Symbol	SIUnits	Symbol
1	Area	Square foot	ft ²	Square centimetre	cm ²	Square metre	m ²	Square metre	m ²
2	Volume	Cubic foot	ft ³	Cubic centimetre	cm ³	Cubic metre	m ³	Cubic metre	m ³
3	Density	Pound per cubic foot	lb/ft ³	Gram per cubic centimetre	g/cm ³	Kilogram per cubic metre	kg/m ³	Kilogram per cubic metre	Kg/m ³
4	Speed	Foot per second	ft/s	Centimetre per second	cm/sec	Metre per second	m/sec	Metre per second	m/sec
5	Velocity (linear)	Foot per second	ft/s	Centimetre per second	cm/sec	Metre per second	m/sec	Metre per second	m/sec
6	Acceleration	Foot per square second	ft/s ²	Centimetre per square second	cm/sec ²	Metre per square second	m/sec ²	Metre per square second	m/sec ²
7	Retardation	Foot per square Second	ft/s ²	Centimetre per square second	cm/sec ²	Metre per square second	m/sec ²	Metre square second	m/sec ²
8	Angular velocity	Degree per second	Deg/sec	Radian per second	rad/sec	Radian per second	rad/sec	Radian per second	rad/sec
9	Mass	Pound (slug)	lb	Gram	g	Kilogram	kg	Kilogram	kg
10	Weight	Pound	lb	Gram	g	Kilogram weight	kg	Newton	N
11	Force	Pounds	lbf	dyne	dyn	Kilogram force	kgf	Newton	N(kgm/sec ²)
12	Power	Foot pound per second	ft.lb/sec	Gram.centimetre/sec	g.cm/sec	kilogram metre per second	kg.m/sec	-	-
		Horse power	hp	Erg per second		watt	W	watt	W(J/sec)
13	Pressure, Stress	Pound per square inch	lb/in ²	Gram per square centimetre	g/cm ²	Kilogram per square metre	kg/m ²	Newton per square metre	N/m ²
14	Energy, Work	Foot.pound	ft.lb	Gram centimetre	g.cm	Kilogram metre	kg.m	joule	J(Nm)
15	Heat	British thermal unit	BTU	calorie	Cal	joule	J	joule	J(Nm)
16	Torque	Pound force foot	lbf.ft	Newton millimetre	N mm	Kilogram metre	kg.m	Newton metre	Nm
17	Temperature	Degree Fahrenheit	°F	Degree Centigrade	°C	Kelvin	K	Kelvin	K

Unit, Fractions - Measurement units and conversion

Units and abbreviations

Quantity	Units	Abbreviation of unit
Calorific value	kilojoules per kilogram	kJ/kg
Specific fuel consumption	kilogram per hour per newton	kg/hr/N
Length	millimetre, metre, kilometre	mm, m, km
Mass	kilogram, gram	kg, g
Time	seconds, minutes, hours	s, min, h
Speed	centimetre per second, metre per second kilometre per hour, miles per hour	cm/s, m/s km/h, mph
Acceleration	metre-per-square second	m/s ²
Force	newtons, kilonewtons	N, kN
Moment	newton-metres	Nm
Work	joules	J
Power	horsepower, watts, kilowatts	Hp, W, kW
Pressure	newton per square metre kilonewton per square metre	N/m ² kN/m ²
Angle	radian	rad
Angular speed	radians per second radians-per-square second revolutions per minute revolutions per second	rad/s rad/s ² Rpm rev/s

Decimal multiples and parts of unit

Decimal power	Value	Prefixes	Symbol	Stands for
10 ¹²	1000000000000	tera	T	billion times
10 ⁹	1000000000	giga	G	thousand millintimes
10 ⁶	1000000	mega	M	million times
10 ³	1000	kilo	K	thousand times
10 ²	100	hecto	h	hundred times
10 ¹	10	deca	da	ten times
10 ⁻¹	0.1	deci	d	tenth
10 ⁻²	0.01	centi	c	hundredth
10 ⁻³	0.001	milli	m	thousandth
10 ⁻⁶	0.000001	micro	μ	millionth
10 ⁻⁹	0.000000001	nano	n	thousand millionth
10 ⁻¹²	0.000000000001	pico	p	billionth

SI units and the British units:

Quantity	SI unit → British unit	British unit → SI unit
Length	1 m = 3.281 ft 1 km = 0.621 mile	1 ft = 0.3048 m 1 mile = 1.609 km
Speed	1 m/s = 3.281 ft/s 1 km/h = 0.621 mph	1 ft/s = 0.305 m/s 1 mph = 1.61 km/h
Acceleration	1 m/s ² = 3.281 ft/s ²	1 ft/s ² = 0.305 m/s ²
Mass	1 kg = 2.205 lb	1 lb = 0.454 kg
Force	1 N = 0.225 lbf 1 MN	1 lbf = 4.448 N 1 million newtons
Torque	1 Nm = 0.738 lbf ft	1 lbf ft = 1.355 Nm
Pressure	1 N/m ² = 0.000145 lbf/in ² 1 Pa = 1 N/m ² 1 bar = 14.5038 lbf/in ²	1 lbf/in ² = 6.896 kN/m ² 1 lbf/in ² = 6.895 kN/m ²
Energy, work	1 J = 0.738 ft lbf 1 J = 0.239 calorie 1 kJ = 0.948 BTU (1 therm = 100 000 BTU) 1 kJ = 0.526 CHU	1 ft lbf = 1.355 J 1 calorie = 4.186 J 1 BTU = 1.055 kJ 1 CHU = 1.9 kJ
Power	1 kW = 1.34 hp	1 hp = 0.7457 kW
Fuel consumption	1 km/L = 2.82 mile/gallon	1 mpg = 0.354 km/L
Specific fuel consumption	1 kg/kWh = 1.65 lb/bhp h 1 litre/kWh = 1.575 pt/bhp h	1 lb/bhp h = 0.606 kg/kWh 1 pt/bhp h = 0.631 litre/kWh
Calorific value	1 kJ/kg = 0.43 BTU/lb 1 kJ/kg = 0.239 CHU/lb	1 BTU/lb = 2.326 kJ/kg 1 CHU/lb = 4.188 kJ/kg

Prefixes for decimal multiples and submultiples

Use	
1 Megapascal	= 1 MPa = 1000000 Pa
1 Kilowatt	= 1 kW = 1000 W
1 Hectolitre	= 1 hL = 100 L
Decanewton	= 1 daN = 10 N
Decimetre	= 1 dm = 0.1 m
1 Centimetre	= 1 cm = 0.01 m
1 Millimetre	= 1 mm = 0.001 m
1 Micrometre	= 1 μ m = 0.000001 m

Conversion factors

1 inch	= 25.4 mm
1 mm	= 0.03937 inch
1 metre	= 39.37 inch
1 micron	= 0.00003937"
1 kilometre	= 0.621 miles
1 pound	= 453.6 g
1 kg	= 2.205 lbs
1 metric ton	= 0.98 ton

Units of physical quantities

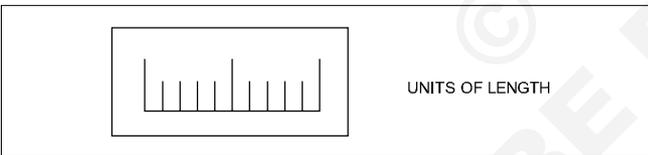

Units of length

Micron	1 μ	= 0.001 mm
Millimetre	1 mm	= 1000 μ
Centimetre	1 cm	= 10 mm
Decimetre	1 dm	= 10 cm
Metre	1 m	= 10 dm
Kilometre	1 km	= 1000 m
Inch	1"	= 25.4 mm
Foot	1'	= 0.305 m
Yard	1 Yd	= 0.914 m
Nautical mile	1 NM	= 1852 m
Geographical mile	1	= 1855.4 m

Units of area

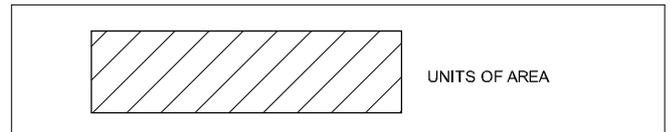

Square millimetre	1 mm ²	
Square centimetre	1 cm ²	= 100 mm ²
Square decimetre	1 dm ²	= 100 cm ²
Square metre	1 m ²	= 100 dm ²
Are	1 a	= 100 m ²
Hectare	1 ha	= 100 a
Square kilometre	1 km ²	= 100 ha
Square inch	1 sq.in	= 6.45 cm ²
Square foot	1 sq.ft	= 0.093 m ²
Square yard	1 sq.yd	= 0.84 m ²
Square metre	1 m ²	= 10.76 ft ²
Acre	1	= 40.5 a
1 Acre = 100 cent		1 Hectare = 2.47 acres
1 Cent = 436 Sq. ft.		1 acre = 0.4047 Hec tare
1 Ground = 2400 Sq.ft.		1 Hectare = 10000 sq. metre

Units of weight

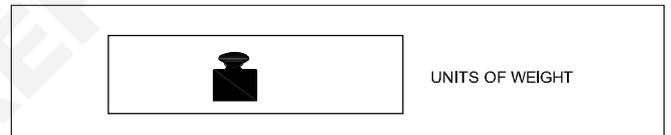

Milligram - force	1 mgf	
Gram-force	1 gf	= 1000 mgf
Kilogram-force	1 kgf	= 1000 gf
Tonne	1 t	= 1000 kgf
Ounce	1	= 28.35 gf
Pound	1 lbs	= 0.454 kgf
Long ton	1	= 1016 kgf
Short ton	1	= 907 kgf

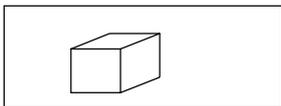

UNITS OF VOLUME AND CAPACITY

Units of volume and capacity

Cubic millimetre	1 mm ³	
Cubic centimetre	1 cm ³	= 1000 mm ³
Cubic decimetre	1 dm ³	= 1000 cm ³
Cubic metre	1 m ³	= 1000 dm ³
Litre	1 l	= 1 dm ³
Hectolitre	1 hl	= 100 l
Cubic inch	1 cu. in	= 16.387 cm ³
Cubic foot	1 cu. ft	= 28317 cm ³
Gallon (British)	1 gal	= 4.54 l
1 cubic metre	1 m ³	= 1000 litres
1000 Cu.cm	1000 cm ³	= 1 litre
1 cubic foot	1 ft ³	= 6.25 Gallon
1 litre	1lt	= 0.22 Gallon

Circular unit

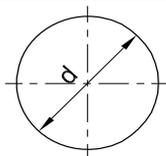

CIRCULAR OF UNIT

Radian

Relationship between Radian and Degree

$$1 \text{ Radian} = \frac{180^\circ}{\pi}$$

$$180^\circ = \pi \text{ Radian};$$

$$1 \text{ Degree} = \frac{\pi}{180} \text{ Radian}$$

Work



WORK

Kilogram-force	1 kgfm	= 9.80665 J
Metre	1 kgfm	= 9.80665 Ws
Joule	1 J	= 1 Nm
Watt-second	1 Ws	= 0.102 kgfm
Kilowatt hour	1 kWh	= 3.6 x 10 ⁶ J
		= 859.8456 kcal _{IT}
I.T.Kilocalorie	1 kcal _{IT}	= 426.kgfm

Power



POWER

Kilogram-force metre/second	
1 kgfm/s	= 9.80665 W
Kilowatt	1 kW = 1000 W = 1000 J/s
	= 102 kgfm/s (approx.)
Metric horse power	1 HP = 75 kgfm/s
	= 0.736 kW
1 Calorie	= 4.187J
I.T.Kilocalorie/hour	= 1 kcal _{IT/h} = 1.163 W

Pressure

Pascal	1 Pa	= 1 N/m ²	1 atm	= 101325 Pa
Bar	1 bar = 10N/cm ²	= 100000 Pa–Torr	1 torr	= $\frac{101325}{760} \approx 133.32 \text{ pa}$
Atmosphere	1 atm	= 1 kgf/cm ²	1 kgf/cm ²	= 735.6 mm of mercury

TEMPERATURE

Scale	Freezing point	Boiling point
Centigrade (°C)	0°C	100°C
Fahrenheit (°F)	32°F	212°F
Kelvin (K)	273K	373K
Reaumur (°R)	0°R	80°R

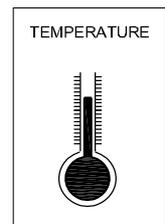

TEMPERATURE

$$\frac{^\circ\text{R}}{80} = \frac{^\circ\text{C}}{100} = \frac{\text{K} - 273}{100} = \frac{^\circ\text{F} - 32}{180}$$

FORCE

Force	In C.G.S. System : Force (Dyne) = Mass (gm) X Acceleration (cm/sec ²)
	In F.P.S. System : Force (Poundal) = Mass (lb) X Acceleration (ft./sec ²)
	In M.K.S System : Force (Newton) = Mass (Kg) x Acceleration (mtr./sec ²)
1 Dyne	= 1 gm x 1 cm/sec ²
1 Poundal	= 1 lb x 1 ft/sec ²
1 Newton	= 1 kg x 1 mtr/sec ² = 10 ⁵ dynes
1gm weight	= 981 Dynes
1 lb weight	= 32 Poundals
1 kg weight	= 9.81 Newtons

ELECTRICAL QUANTITIES

V	Electric potential	V	Volt	V(W/A)
E	Electromotive force	V	Volt	V(W/A)
I	Electric current	A	Ampere	A
R	Electric resistance	Ω	Ohm	Ω (V/A)
e	Specific resistance	Ω m	Ohm metre	Vm/A
G	Conductance	Ω ⁻¹	Siemens	S

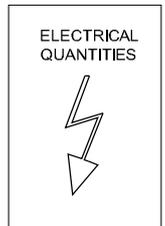

Assignment - Answer the following question.

- 1 Convert 320 kilometres into miles _____
- 2 Convert 16 tons into kilograms _____
- 3 Convert 40 inches into centimetres _____
- 4 Convert 8 metres into feet _____
- 5 Convert 2.5 gallons into litres _____
- 6 Convert 5 litres into gallons _____
- 7 120°C = _____ °F.
- 8 Expand the abbreviations of the following
 - a N/m²
 - b RPM
- 9 Convert the following S.I. units as required.
 - a Length
 - i 3.4 m = _____ mm
 - ii 10.2 km = _____ mile
 - b Mass
 - i 650 g = _____ kg
 - ii 120 mg = _____ g
 - c Force
 - i 1.2 N = _____ kg
 - ii 25 kg = _____ N
 - d Work, energy, amount of heat
 - i 120 KJ = _____ J
 - ii 300 wh = _____ kwh
 - e Power
 - i 0.2 kW = _____ W
 - ii 350 W = _____ kW
 - f Convert as required.
 - i 5 N = _____ KN

Unit, Fractions - Factors, HCF, LCM and problems

Prime Numbers and whole Numbers

Factor

A factor is a small number which divides exactly into a bigger number.e.g.

To find the factors of 24, 72, 100 numbers

$$24 = 2 \times 2 \times 2 \times 3$$

$$72 = 2 \times 2 \times 2 \times 3 \times 3$$

$$100 = 2 \times 2 \times 5 \times 5$$

The numbers 2,3,5 are called factors.

Definition of a prime factor

Prime factor is a number which divides a prime number into factors.e.g.

$$57 = 3 \times 19$$

The numbers 3 and 19 are prime factors.

They are called as such, since 3 & 19 also belong to prime number category.

Definition of H.C.F

The Highest Common Factor

The H.C.F of a given group of numbers is the highest number which will exactly divide all the numbers of that group.e.g.

To find the H.C.F of the numbers 24, 72, 100

$$24 = 2 \times 2 \times 2 \times 3$$

$$72 = 2 \times 2 \times 2 \times 3 \times 3$$

$$100 = 2 \times 2 \times 5 \times 5$$

The factors common to all the three numbers are

$$2 \times 2 = 4. \text{ So HCF} = 4.$$

Definition of L.C.M

Lowest common multiple

The lowest common multiple of a group of numbers is the smallest number that will contain each number of the given group without a remainder.e.g.

- Factorise the following numbers

$$7,17,20,66,128$$

7,17 - These two belong to Prime numbers. Hence no factor except unity and itself.

$$\begin{array}{r|l} 2 & 20 \\ 2 & 10 \\ & 5 \end{array}$$

Factors of 20 = $2 \times 2 \times 5$

$$\begin{array}{r|l} 2 & 66 \\ 3 & 33 \\ & 11 \end{array}$$

Factors of 66 = $2 \times 3 \times 11$

$$\begin{array}{r|l} 2 & 128 \\ 2 & 64 \\ 2 & 32 \\ 2 & 16 \\ 2 & 8 \\ 2 & 4 \\ & 2 \end{array}$$

Factors of 128 = $2 \times 2 \times 2 \times 2 \times 2 \times 2 \times 2$

- Select prime numbers from 3 to 29
3,5,7,11,13,17,19,23,29
- Find the HCF of the following group of numbers HCF of 78, 128, 196

$$\begin{array}{r|l} 2 & 78 \\ 3 & 39 \\ & 13 \end{array}$$

$$78 = 2 \times 3 \times 13$$

$$\begin{array}{r|l} 2 & 128 \\ 2 & 64 \\ 2 & 32 \\ 2 & 16 \\ 2 & 8 \\ 2 & 4 \\ & 2 \end{array}$$

$$128 = 2 \times 2 \times 2 \times 2 \times 2 \times 2 \times 2$$

$$\begin{array}{r|l} 2 & 196 \\ 2 & 98 \\ & 49 \end{array}$$

$$196 = 2 \times 2 \times 49$$

$$\text{HCF} = 2$$

- Find LCM of 84,92,76

$$\text{LCM} = \begin{array}{r|l} 2 & 84, 92, 76 \\ 2 & 42, 46, 38 \\ 3 & 21, 23, 19 \\ & 7, 23, 19 \end{array}$$

$$\text{LCM} = 2 \times 2 \times 3 \times 7 \times 23 \times 19 = 36708$$

- To find out the LCM of 36, 108, 60

$$\begin{array}{r|l} 2 & 36, 108, 60 \\ 2 & 18, 54, 30 \\ 3 & 9, 27, 15 \\ 3 & 3, 9, 5 \\ & 1, 3, 5 \end{array}$$

LCM of the number

$$36, 108, 60 = 2 \times 2 \times 3 \times 3 \times 3 \times 5 = 540$$

The necessity of finding LCM and HCF arises in subtraction and addition of fractions.

Unit, Fractions - Fractions - Addition, subtraction, multiplication & division

Description

A minimal quantity that is not a whole number. For e.g. .

$\frac{1}{5}$ a vulgar fraction consists of a numerator and denominator.

Numerator/Denominator

The number above the line in a vulgar fraction showing how many of the parts indicated by the denominator are taken is the numerator. The total number of parts into which the whole quantity is divided and written below the line in a vulgar fraction is the denominator. e.g.

$$\frac{1}{4}, \frac{3}{4}, \frac{7}{12}$$

1,3,7 - numerators 4,12 - denominators

Fraction: Concept

Every number can be represented as a fraction.e.g.

$1\frac{1}{4} = \frac{5}{4}$, A full number can be represented as an apparent fraction.e.g. (Fig 1)

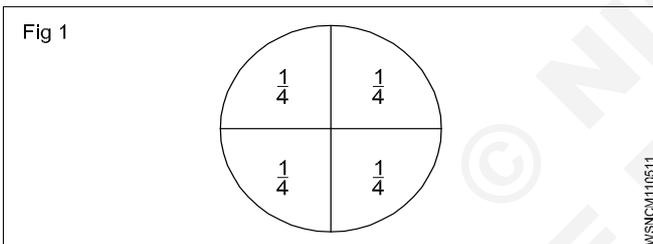

Fraction: Value

The value of a fraction remains the same if the numerator and denominator of the fraction are multiplied or divided by the same number.(Fig 2)

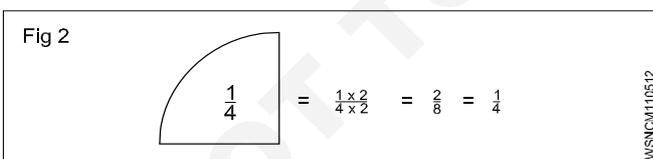

Multiplication

When fractions are to be multiplied, multiply all the numerators to get the numerator of the product and multiply all the denominators to form the denominator of the product. (Fig 3)

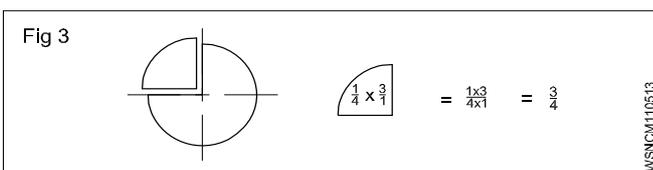

Division

When a fraction is divided by another fraction the dividend is multiplied by the reciprocal of the divisor. (Fig 4)

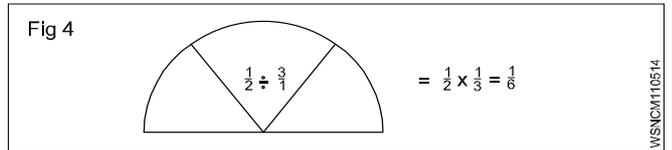

Addition and Subtraction

The denominators of the fractions should be the same when adding or subtracting the fractions. Unequal denominators must first be formed into a common denominator. It is the lowest common denominator and it is equal to the product of the most common prime numbers of the denominators of the fractions in question.(Fig 5)

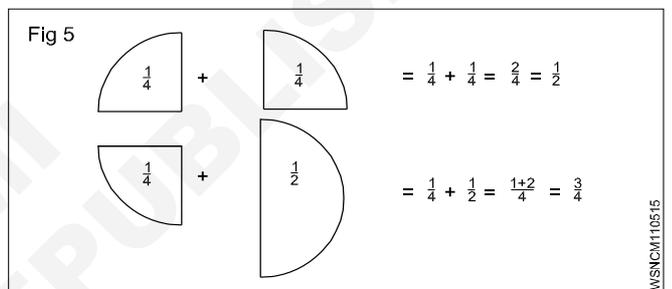

Examples

- Multiply $\frac{3}{4}$ by $\frac{2}{3}$,

$$\frac{3}{4} \times \frac{2}{3} = \frac{6}{12} = \frac{1}{2}$$

- Divide $\frac{3}{8}$ by $\frac{3}{4}$,

$$\frac{3}{8} \div \frac{3}{4} = \frac{3}{8} \times \frac{4}{3} = \frac{1}{2}$$

- Add $\frac{3}{4}$ and $\frac{2}{3}$,

$$\frac{3}{4} + \frac{2}{3} = \frac{9}{12} + \frac{8}{12} = \frac{17}{12} = 1\frac{5}{12}$$

- sub $\frac{7}{16}$ from $\frac{17}{32}$

$$\frac{17}{32} - \frac{7}{16} = \frac{17}{32} - \frac{14}{32} = \frac{(17 - 14)}{32} = \frac{3}{32}$$

Types of fractions

- Proper fractions are less than unity. Improper fractions have their numerators greater than the denominators.
- A mixed number has a full number and a fraction.

Addition of fraction

$$\text{Add } \frac{1}{2} + \frac{1}{8} + \frac{5}{12}$$

To add these fractions we have to find out L.C.M of denominators 2,8,12.

Find L.C.M of 2,8,12

Step 1 L.C.M

2	2,8,12
2	1,4,6
	1,2,3

Factors are 2,2,2,3

Hence L.C.M = $2 \times 2 \times 2 \times 3 = 24$

Step 2

$$\begin{aligned} \frac{1}{2} + \frac{1}{8} + \frac{5}{12} &= \frac{12}{24} + \frac{3}{24} + \frac{10}{24} \\ &= \frac{12+3+10}{24} = \frac{25}{24} = 1\frac{1}{24} \end{aligned}$$

Subtraction of fraction

$$\text{subtract } 9\frac{15}{32} \text{ from } 17\frac{9}{16} \text{ or } (17\frac{9}{16} - 9\frac{15}{32})$$

Step 1: Subtract whole number first $17 - 9 = 8$

Step 2: L.C.M of 16,32 = 32

Since number 16 divides the number 32

$$\text{Subtracting fractions} = \frac{3}{32}$$

Adding with whole number from Step 1

$$\text{we get } 8 + \frac{3}{32} = 8\frac{3}{32}$$

Common fractions

Problems with plus and minus sign

Example

$$\text{solve } 3\frac{3}{4} + 6\frac{7}{8} - 4\frac{5}{16} - \frac{9}{32}$$

Rule to be followed

- 1 Add all whole numbers
- 2 add all + Numbers
- 3 Add all - Numbers
- 4 Find L.C.M of all denominators

Solution

Step 1: Add whole numbers = $3 + 6 - 4 = 5$

$$\text{Step 2: Add fractions} = \frac{3}{4} + \frac{7}{8} - \frac{5}{16} - \frac{9}{32}$$

L.C.M of 4,8,16,32 is 32

$$\begin{aligned} &\frac{24 + 28 - 10 - 9}{32} \\ &= \frac{52 - 19}{32} \\ &= \frac{33}{32} = 1\frac{1}{32} \end{aligned}$$

Step 3: Adding again with the whole number

$$\text{we get } 5 + 1\frac{3}{32} = 6\frac{3}{32}$$

Examples

Common fractions

- Multiply

$$\text{a } \frac{3}{8} \text{ by } \frac{4}{7} = \frac{3}{8} \times \frac{4}{7} = \frac{3}{14} \quad \text{b } \frac{2}{3} \times \frac{3}{4} \times \frac{5}{8} = \frac{5}{16}$$

- Division

$$\text{a } \frac{5}{16} \div \frac{5}{32} = \frac{5}{16} \times \frac{32}{5} = 2$$

$$\text{b } 4\frac{2}{3} \div 3\frac{1}{7} = \frac{14}{3} \div \frac{22}{7} = \frac{14}{3} \times \frac{7}{22} = \frac{49}{33} = 1\frac{16}{33}$$

- Addition

$$\frac{1}{2} + \frac{1}{4} + \frac{1}{8}$$

L.C.M = 2,4,8 = 8

$$\frac{1}{2} + \frac{1}{4} + \frac{1}{8} = \frac{4+2+1}{8} = \frac{7}{8}$$

- Subtraction

$$5\frac{1}{4} - 3\frac{3}{4} = 5 - 3 + \frac{1}{4} - \frac{3}{4}$$

$$= 2 + \frac{1}{4} - \frac{3}{4} = 2 - \frac{2}{4}$$

$$= \frac{9}{4} - \frac{3}{4} = \frac{9-3}{4}$$

$$= \frac{6}{4} = \frac{3}{2} = 1\frac{1}{2}$$

Assignment

1 Convert the following into improper fractions.

a $1\frac{2}{7} = \underline{\hspace{2cm}}$

b $4\frac{3}{5} = \underline{\hspace{2cm}}$

c $3\frac{3}{5} = \underline{\hspace{2cm}}$

2 Convert the following into mixed numbers.

a $\frac{12}{11} = \underline{\hspace{2cm}}$

b $\frac{36}{14} = \underline{\hspace{2cm}}$

c $\frac{18}{10} = \underline{\hspace{2cm}}$

3 Place the missing numbers.

a $\frac{11}{13} = \frac{x}{91}$ _____

b $\frac{3}{5} = \frac{42}{x}$ _____

c $\frac{9}{14} = \frac{x}{98}$ _____

4 Simplify.

a $\frac{45}{60} = \underline{\hspace{2cm}}$

b $\frac{8}{12} = \underline{\hspace{2cm}}$

5 Multiply.

a $5 \times \frac{2}{3} = \underline{\hspace{2cm}}$

b $\frac{3}{4} \times 2 = \underline{\hspace{2cm}}$

c $\frac{3}{4} \times \frac{5}{6} = \underline{\hspace{2cm}}$

6 Divide

a $\frac{1}{4} \div \frac{3}{4} = \underline{\hspace{2cm}}$

b $6 \div \frac{3}{4} = \underline{\hspace{2cm}}$

c $\frac{3}{4} \div \frac{2}{7} = \underline{\hspace{2cm}}$

7 Place the missing numbers.

a $\frac{2}{3} = \frac{1}{12} \times \underline{\hspace{2cm}}$

b $\frac{14}{24} = \frac{1}{12} \times \underline{\hspace{2cm}}$

c $\frac{7}{8} = \frac{1}{12} \times \underline{\hspace{2cm}}$

8 Add the followings:

a $\frac{3}{4} + \frac{7}{12} = \underline{\hspace{2cm}}$

b $\frac{7}{8} + \frac{3}{4} = \underline{\hspace{2cm}}$

9 Subtract

a $\frac{4}{5} - \frac{2}{5} = \underline{\hspace{2cm}}$

b $\frac{5}{6} - \frac{3}{4} = \underline{\hspace{2cm}}$

10 Simplify

a $2\frac{6}{7} - \frac{3}{8} - \frac{1}{3} - 1\frac{1}{16} = \underline{\hspace{2cm}}$

b $2\frac{2}{7} - \frac{5}{6} + 8 = \underline{\hspace{2cm}}$

11 Express as improper fractions

a $5\frac{3}{4}$

b $3\frac{5}{64}$

c $1\frac{5}{12}$

Unit, Fractions - Decimal fractions - Addition, subtraction, multiplication & division

Description

Decimal fraction is a fraction whose denominator is 10 or powers of 10 or multiples of 10 (i.e.) 10, 100, 1000, 10000 etc. Meaning of a decimal number:-

12.3256 means

$$(1 \times 10) + (2 \times 1) + \frac{3}{10} + \frac{2}{100} + \frac{5}{1000} + \frac{6}{10000}$$

Representation

The denominator is omitted. A decimal point is placed at different positions of the number corresponding to the magnitude of the denominator

Ex. $\frac{5}{10} = 0.5, \frac{35}{100} = 0.35, \frac{127}{10000} = 0.0127, \frac{3648}{1000} = 3.648$

Addition and subtraction

Arrange the decimal fractions in a vertical order, placing the decimal point of each fraction to be added or subtracted, in succession one below the other, so that all the decimal points are arranged in a straight line. Add or subtract as you would do for a whole number and place the decimal point in the answer below the column of decimal points.

Decimal fractions less than 1 are written with a zero before the decimal point. Example: $45/100 = 0.45$ (and not simply .45)

Add $0.375 + 3.686$

$$\begin{array}{r} 0.375 \\ 3.686 \\ \hline 4.061 \end{array}$$

Subtract 18.72 from 22.61

$$\begin{array}{r} 22.61 \\ 18.72 \\ \hline 3.89 \end{array}$$

Multiplication

Ignore the decimal points and multiply as whole numbers. Find the total number of digits to the right of the decimal point. Insert the decimal point in the answer such that the number of digits to the right of the decimal point equals to the sum of the digits found to the right of the decimal points in the problem.

Multiply 2.5 by 1.25

= $25 \times 125 = 3125$. The sum of the figures to the right of decimal point is 3. Hence the answer is 3.125.

Division

Move the decimal point of the divisor to the right to make it a full number. Move the decimal point in the dividend to

the same number of places, adding zeroes if necessary. Then divide.

Divide 0.75 by 0.25

$$0.25 \overline{)0.75}$$

$$\frac{0.75}{0.25} \times \frac{100}{100} = \frac{75}{25}$$

$$25 \overline{)75} = 3$$

Move the decimal point in the multiplicand to the right to one place if the multiplier is 10, and to two places if the multiplier is 100 and so on. When dividing by 10 move the decimal point one place to the left, and, if it is by 100, move them point by two places and so on.

Example

Allowance allowing 3 mm for cutting off each pin, how many pins can be made from a 900 mm long bar and how much material will be left out?

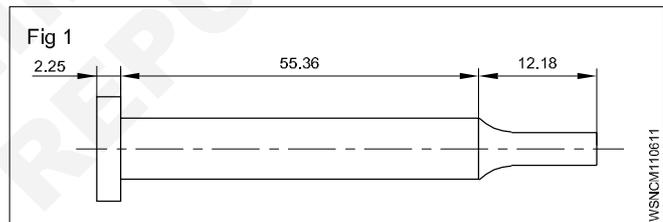

Total Length of pin = $2.25 + 55.36 + 12.18$
= 69.79 mm

Cutting allowance = 3 mm

Total Length = length of pin + cutting allowance
= $69.79 \text{ mm} + 3 \text{ mm}$
= 72.79 mm

Length of the bar = 900 mm

No. of pins to be cut = $\frac{900}{72.79} = 12.394$
= 12 pins

Left out material = Total length - length of pin + cutting allowance
= $900 - 12 \times 69.79 + 12 \times 3$
= $900 - 837.48 + 36$
= $900 - 873.48$

Left out length = 26.52 mm

Conversion of Decimals into fractions and vice-versa

- Convert decimal into fractions

Example

Convert 0.375 to a fraction

Now place 1 under the decimal point followed by as many zeros as there are numbers

$$0.375 = \frac{375}{1000} = \frac{15}{40} = \frac{3}{8}$$

$$0.375 = \frac{3}{8}$$

- Convert fraction into decimal

Example

- Convert $\frac{9}{16}$ to a decimal

Proceed to divide $\frac{9}{16}$ in the normal way of division but put zeros (as required) after the number 9 (Numerator)

$$\begin{array}{r} 0.5625 \\ 16 \overline{)90000} \\ \underline{80} \\ 100 \\ \underline{96} \\ 40 \\ \underline{32} \\ 80 \\ \underline{80} \\ 0 \end{array}$$

$$\frac{9}{16} = 0.5625$$

Recurring decimals

While converting from fraction to decimals, some fractions can be divided exactly into a decimal. In some fractions the quotient will not stop. It will continue and keep recurring. These are called recurring decimals.

Examples

- convert $\frac{1}{3}, \frac{2}{3}, \frac{1}{7}$

a $\frac{1}{3} = \frac{10000}{3} = 0.3333$ – Recurring

b $\frac{2}{3} = \frac{20000}{3} = 0.666$ – Recurring

c $\left(\frac{1}{7} = \frac{10000}{7} = 0.142857142 \right)$ – Recurring

Method of writing approximations in decimals

$$1.73556 = 1.7356 \text{ Correct to 4 decimal places}$$

$$5.7343 = 5.734 \text{ Correct to 3 decimal places}$$

$$0.9345 = 0.94 \text{ Correct to 2 decimal places}$$

Multiplication and division by 10, 100, 1000

Multiplying decimals by 10

A decimal fraction can be multiplied by 10, 100, 1000 and so on by moving the decimal point to the right by as many places as there are zeros in the multiplier.

- $4.645 \times 10 = 46.45$ (one place)
- $4.645 \times 100 = 464.5$ (two places)
- $4.645 \times 1000 = 4645$ (three places)

Dividing decimals by 10

A decimal fraction can be divided by 10, 100, 1000 and so on, by moving the decimal point to the left by as many places as required in the divisor by putting zeros

Examples

- $3.732 \div 10 = 0.3732$ (one place)
- $3.732 \div 100 = 0.03732$ (two places)
- $3.732 \div 1000 = 0.003732$ (three places)

Examples

- Rewrite the following number as a fraction

453.273

$$= (4 \times 100) + (5 \times 10) + (3 \times 1) + \frac{2}{10} + \frac{7}{100} + \frac{3}{1000}$$

$$= 453 \frac{273}{1000}$$

- Write the representation of decimal places in the given number 0.386

- 3 - 1st decimal place
- 8 - 2nd decimal place
- 6 - 3rd decimal place

- Write approximations in the following decimals to 3 places.

- a $6.9453 \longrightarrow 6.945$
- b $8.7456 \longrightarrow 8.746$

- Convert fraction to decimal

$$\frac{21}{24} = \frac{7}{8} = 0.875$$

- Convert decimal to fraction

$$0.0625 = \frac{625}{10000} = \frac{5}{80} = \frac{1}{16}$$

Assignment

- 1 Write down the following decimal numbers in the expanded form.
- a 514.726
b 902.524
- 2 Write the following decimal numbers from the expansion.
- a $500 + 70 + 5 + \frac{3}{10} + \frac{2}{100} + \frac{9}{1000}$
b $200 + 9 + \frac{1}{10} + \frac{3}{100} + \frac{5}{1000}$
- 3 Convert the following decimals into fractions in the simplest form.
- a 0.72
b 5.45
c 3.64
d 2.05
- 4 Convert the following fraction into decimals
- a $\frac{3}{5}$
b $\frac{10}{4}$
c $24 \frac{54}{1000}$
d $\frac{12}{25}$
e $\frac{8}{25}$
f $1 \frac{3}{25}$
- 5 Addition of decimals
- a $4.56 + 32.075 + 256.6245 + 15.0358$
b $462.492 + 725.526 + 309.345 + 626.602$
- 6 Subtract the following decimals
- a $612.5200 - 9.6479$
b $573.9246 - 215.6000$
- 7 Add and subtract the following
- a $56.725 + 48.258 - 32.564$
b $16.45 + 124.56 + 62.7 - 3.243$
- 8 Multiply the following
- a By 10,100,1000
i 3.754×10
ii 8.964×100
iii 2.3786×1000
iv 0.005×1000
- b By whole numbers
i 8.4×7
ii 56.72×8
- c By another decimal figure (use calculator)
i 15.64×7.68
ii 2.642×1.562
- 9 Divide the following
- a $\frac{62.5}{25}$
b $\frac{64.56}{10}$
c $\frac{0.42}{100}$
d $\frac{48.356}{1000}$
- 10 Division
- a $\frac{16.8}{1.2}$
b $\frac{1.54}{1.1}$
- 11 Change the fraction into a decimal
- i $1 \frac{5}{8}$
ii $\frac{12}{25}$
- 12 Find the value
 $20.5 \times 40 \div 10.25 + 18.50$

Unit, Fractions - Solving problems by using calculator

A pocket calculator allows to spend less time in doing tedious calculations. A simple pocket calculator enables to do the arithmetical calculations of addition, subtraction, multiplication and division, while a scientific type of calculator can be used for scientific and technical calculations also.

No special training is required to use a calculator. But it is suggested that a careful study of the operation manual of the type of the calculator is essential to become familiar with its capabilities. A calculator does not think and do. It is left to the operator to understand the problem, interpret the information and key it into the calculator correctly.

Constructional Details (Fig 1)

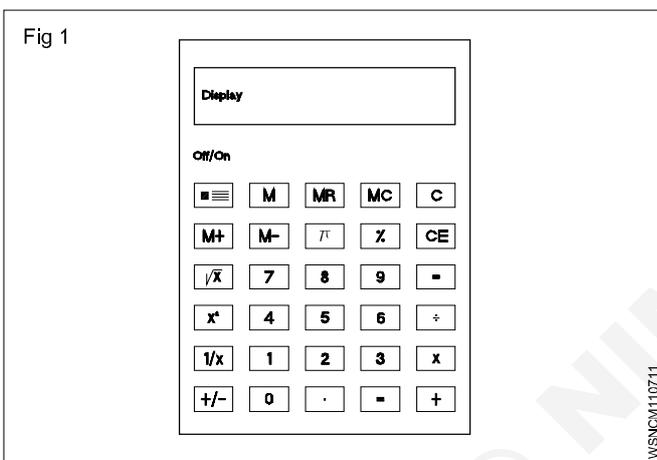

The key board is divided into five clear and easily recognizable areas and the display.

• Data entry keys

The entry keys are from 0to 9

and a key for the decimal point . .

• Clearing keys

These keys have the letter 'C'

C CLR Clear totally

CE Clear entry only

CM , MC Clear memory

- + Addition key
- Subtraction key
- x Multiplication key
- ÷ Division key
- = Equals key to display the result

• Function keys

- π Pi key
- √x Square root key
- % Percentage key
- +/- Sign change key
- x² Square key
- 1/x Reciprocal key

• Memory keys

- M Store the display number
- M+ The displayed value is added to the memory
- M- The displayed value is subtracted from the memory
- MR RCL The stored value is recalled on to the display

Further functional keys included in Scientific calculators are as shown in Fig 2.

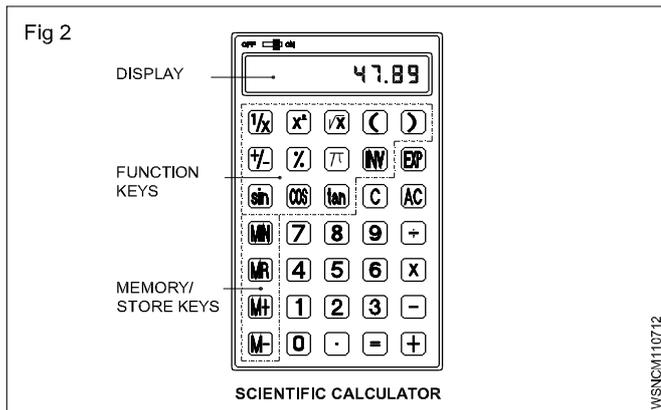

\sin \cos \tan $($ $)$ For trigonometric functions and for brackets

\exp Exponent key

INV Some of the keys have coloured lettering above or below them. To use a function in coloured lettering, press INV key. INV will appear on the display. Then press the key that the coloured lettering identifies. INV will disappear from the display.

\log , INV 10^x to obtain the logarithm of the displayed number and the antilogarithm of the displayed value.

INV R-P to convert displayed rectangular coordinates into polar coordinates.

INV P-R to convert displayed polar coordinates into rectangular coordinates.

• The display

The display shows the input data, interim results and answers to the calculations.

The arrangement of the areas can differ from one make to another. Keying in of the numbers is done via an internationally agreed upon set of ten keys in the order that the numbers are written.

Rules and Examples:

- **Addition:** Example $18.2 + 5.7$

Sequence	Input	Display
Input of the 1st term of the sum	18.2	18.2
Press + key	$+$	18.2
Input 2nd term of the sum. the first term goes into the register	5.7	5.7
Press the = key	$=$	23.9

- **Subtraction:** Example $128.8 - 92.9$

Sequence	Input	Display
Enter the subtrahend	128.8	128.8
Press - key	$-$	128.8
Enter the minuend. The subtrahend goes into the register	92.9	92.9
Press the = key	$=$	35.9

- **Multiplication:** Example 0.47×2.47

Sequence	Input	Display
Enter multiplicand	0.47	0.47
Press x key	\times	0.47
Enter multiplier, multiplicand goes to register	2.47	2.47
Press = key	$=$	1.1609

- **Division:** Example $18.5/2.5$

Sequence	Input	Display
Enter the dividend	18.5	18.5
Press \div Key	\div	18.5
Enter the divisor goes to the register	2.5	2.5
Press = key	$=$	7.4

- **Multiplication & Division:**
Example : 2.5 x 7.2 / 4.8 x 1.25

Sequence	Input	Display
Enter 2.5	2 . 5	2.5
Press x key	x	2.5
Enter 7.2	7 . 2	7.2
Press ÷ key	÷	18
Enter Open bracket	(
Enter 4.8	4 . 8	4.8
Press x key	x	4.8
Enter 1.25	1 . 2 5	1.25
Enter Close bracket)	6
Press = key	=	3.0

- Store in memory Example (2+6) (4+3)

Sequence	Input	Display
Workout for the first bracket	2	2
	+	2
	6	6
	=	8
Store the first result in	STO , M	8
x	or M+	
Workout for the 2nd bracket	4	4
	+	4
	3	3
	=	7
Press x key	x	7
Recall memory	RCL or MR	8
Press = key	=	56

- **Percentage:** Example 12% of 1500

Sequence	Input	Display
Enter 1500	1 5 0 0	1500
Press x key	x	1500
Enter 12	1 2	12
Press INV %	INV %	12
Press = key	=	180

- **Square root:** Example $\sqrt{2} + \sqrt{3 \times 5}$

Sequence	Input	Display
Enter 2	2	2
Press \sqrt{a} key	\sqrt{a}	1.414
Press + key	+	1.414
Press bracket key	(1.414
Enter 3	3	3
Press \sqrt{a} key	\sqrt{a}	1.732
Press x key	x	1.732
Enter 5	5	5
Press \sqrt{a} key	\sqrt{a}	2.236
Press bracket close key)	3.873
Press = key	=	5.2871969
	2 \sqrt{a} + (3 \sqrt{a} x 5 \sqrt{a}) =	5.2871969

$$\sqrt{2} + \sqrt{3 \times 5} = 5.287$$

- **Common logarithm:** Example log 1.23

Sequence	Input	Display
	1 . 2 3 log =	0.0899051

- **Power:** Example $123 + 30^2$

Sequence	Input	Display
	1 2 3 + 3 0 INV X ² =	1023

- Before starting the calculations be sure to press the 'ON' key and confirm that '0' is shown on the display.
- Do not touch the inside portion of the calculator. Avoid hard knocks and unduly hard pressing of the keys.
- Maintain and use the calculator in between the two extreme temperatures of 0° and 40° C.

- Never use volatile fluids such as lacquer, thinner, benzene while cleaning the unit.
- Take special care not to damage the unit by bending or dropping.
- Do not carry the calculator in your hip pocket.

Assignment

1 Using calculator solve the following

- $625 + 3467 + 20 + 341 + 6278 =$ _____
- $367.4 + 805 + 0.7 + 7.86 + 13.49 =$ _____
- $0.043 + 1.065 + 13.0 + 34.76 + 42.1 =$ _____
- $47160 + 1368.4 + 0.1 + 1.6901 + 134.267 =$ _____

2 Using calculator simplify the following

- $24367 - 4385 =$ _____
- $9.643 - 0.7983 =$ _____
- $4382.01 - 381.3401 =$ _____
- $693.42 - 0.0254 =$ _____

3 Using calculator find the values of the following

- $23 \times 87 =$ _____
- $1376 \times 0.81 =$ _____
- $678 \times 243 =$ _____
- $0.75 \times 0.24 =$ _____

4 Using calculator solve the following

- $22434 \div 3 =$ _____
- $4131 \div 243 =$ _____
- $469890 \div 230 =$ _____
- $3.026 \div 0.89 =$ _____

5 Solve the following

- $\frac{1170 \times 537.5}{13 \times 215} =$ _____
- $\frac{28.2 \times 18 \times 3500}{1000 \times 3 \times 0.8} =$ _____

6 Solve the following

- $\frac{(634 + 128) \times (384 - 0.52)}{8 \times 0.3} =$ _____

$$b \frac{(389 - 12.2) \times (842 - 0.05 - 2.6)}{(3.89 - 0.021) \times (28.1 + 17.04)} =$$

7

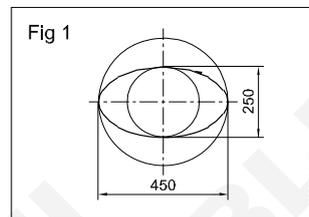

$$2a = 450 \text{ mm (major axis)}$$

$$2b = 250 \text{ mm (minor axis)}$$

Perimeter of the ellipse

$$A = \text{_____ metre}^2$$

$$\text{Hint } A = \pi \times a \times b \text{ unit}^2$$

8

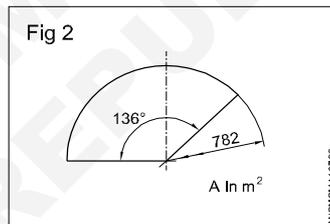

$$\phi = 782 \text{ mm}$$

$$\alpha = 136^\circ$$

Area of the sector

$$A = \text{_____}$$

$$\text{Hint } A = \frac{\pi \times d^2}{4} \times \frac{\alpha}{360^\circ}$$

9

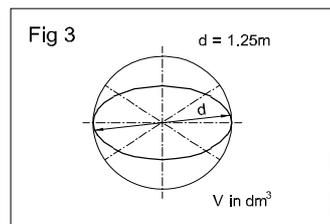

$$d = 1.25 \text{ metre}$$

$$V = \text{_____ dm}^3$$

Volume of sphere

$$\text{Hint } V = \frac{4}{3} \pi r^3$$

10

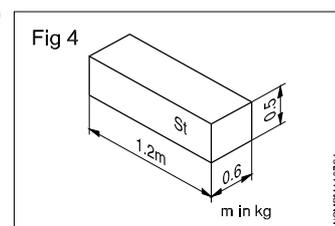

$$L = 1.2 \text{ metres}$$

$$B = 0.6 \text{ metre}$$

$$H = 0.5 \text{ metre}$$

' ρ ' (rho) density of steel

$$= 7.85 \text{ kg/dm}^3$$

$$m = \text{_____ kg}$$

$$\text{(mass 'm' = V x } \rho \text{)}$$

Square root, Ratio and Proportions, Percentage - Square and square root

- a basic number
- 2 exponent

√ radical sign indicating the square root.

√a² square root of 'a' square

a² radicand

Square number

The square of a number is the number multiplied by itself.

Basic number x basic number = Square number

a x a = a²

4 x 4 = 4² = 16

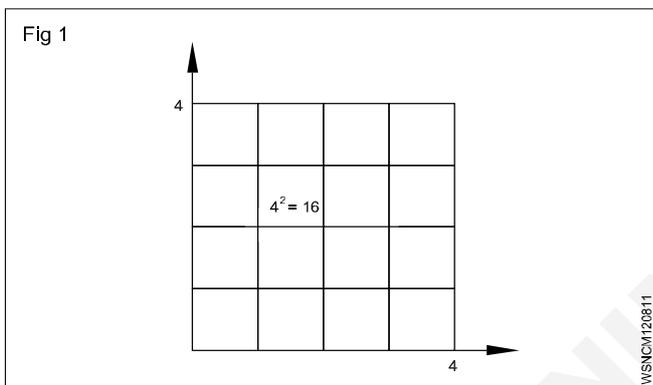

Splitting up

A square area can be split up into sub-areas. The largest square of 36 is made up of a large square 16, a small square 4 and two rectangles 8 each.

Large square 4 x 4 = 16 a²

Two rectangles 2 x 4 = 8 2ab

Small square 2 x 2 = 4 b²

Sum of sub-areas = 36 = a² + 2ab + b²

√36 = √a² + 2ab + b²

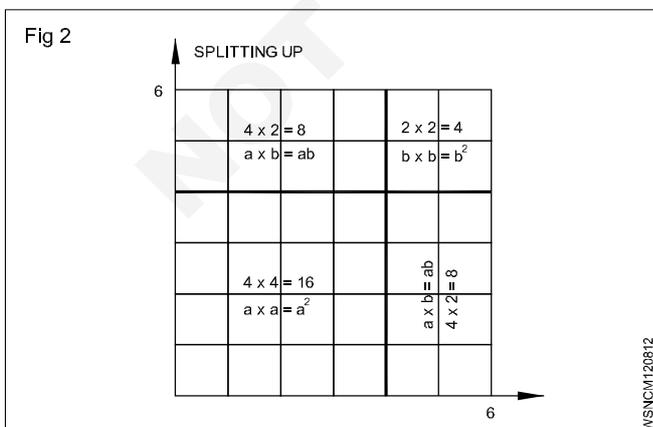

Result: In order to find the square root, we split up the square numbers.

Extracting the square root procedure

- Starting from the decimal point form groups of two figures towards right and left. Indicate by a prime symbol. √4624.00
- Find the root of the first group, calculate the difference, bring down the next group.
- Multiply the root by 2 and divide the partial radicand.
- Enter the number thus calculated in the divisor for the multiplication.

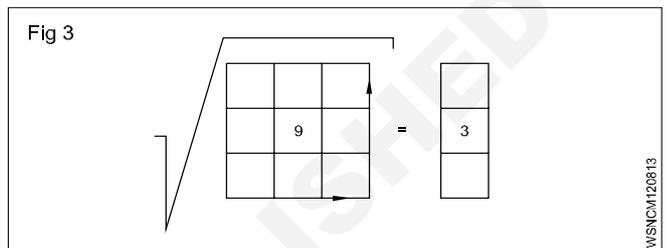

If there is a remainder, repeat the procedure.

$$\begin{array}{r}
 68 \\
 6 \overline{) 46,24} \\
 \underline{36} \\
 1024 \\
 \underline{1024} \\
 0
 \end{array}$$

√4624 = 68

Basic number x basic number = Square

√Square number = basic number

Example

The cross-section of a rivet is 3.46 cm². Calculate the diameter of the hole.

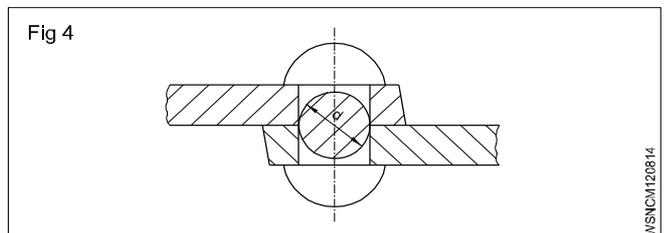

Rivet cross-section is the hole cross-section.

To find 'd',

Given that Area = 3.46 cm²

Area = 0.785 x d² (formula)

3.46 cm² = d² x 0.785

$$d^2 = \frac{3.46 \text{ cm}^2}{0.785}$$

$$d = \sqrt{\frac{3.46}{0.785}} \text{ cm}$$

d = 2.1 cm (or) 21mm

Square root, Ratio and Proportions, Percentage - Simple problems using calculator

1 a $\sqrt{2916} =$ _____.

b $\sqrt{45796} =$ _____.

c $\sqrt{8.2944} =$ _____.

d $\sqrt{63.845} =$ _____.

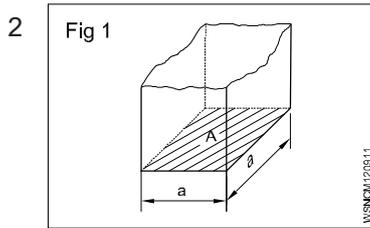

A = 2025 mm²
a = _____ mm

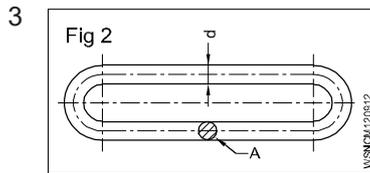

A = 176.715 mm²
d = _____ mm

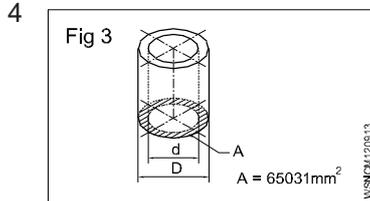

A = 65031 mm²
d = 140 mm
D = _____ mm

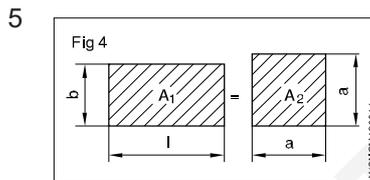

l = 58 cm
b = 45 cm
A₁ = A₂
a = _____ cm

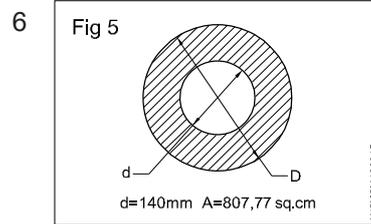

A = 807.77 cm²
d = 140 mm
D = _____ mm

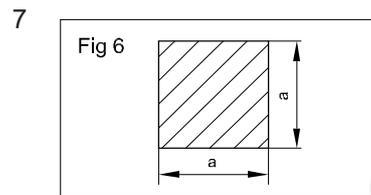

a x a = 543169 mm²
a = _____ mm

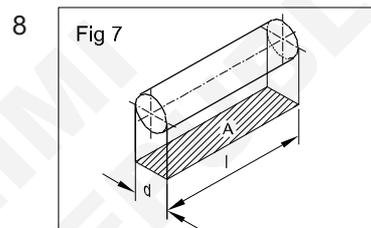

d : l = 1:1.5
A = 73.5 mm²
d = _____ mm

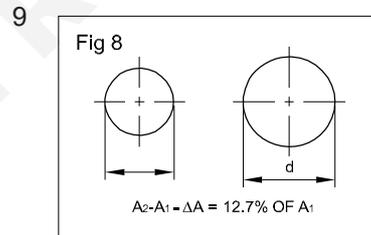

increase in area
A = 12.7%
A = 360 mm²
d = _____ mm
(d = diameter after the increase in area)

Square root, Ratio and Proportions, Percentage - Applications of pythagoras theorem and related problems

Applications of Pythagoras Theorem

Some of the applications of the Pythagoras theorem are; (Fig 1)

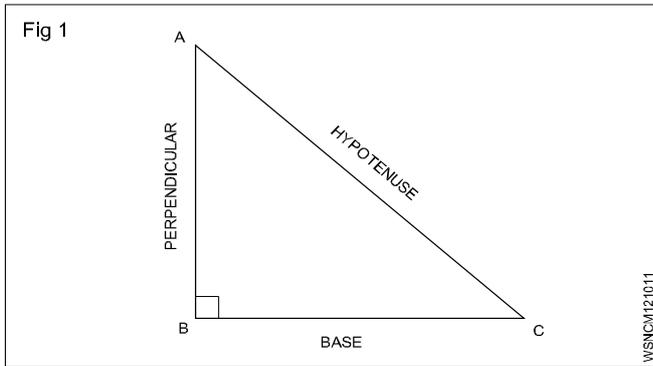

- 1 The Pythagoras theorem is commonly used to find the lengths of sides of a right-angled triangle.
- 2 It is used to find the length of the diagonal of a square.
- 3 Pythagoras theorem is used in trigonometry to find the trigonometric ratios like sin, cos, tan, cosec, sec and cot.
- 4 Pythagoras theorem is used in security cameras for face recognition.
- 5 Architects use the technique of the Pythagoras theorem for engineering and construction fields.
- 6 The Pythagoras theorem is applied in surveying the mountains.
- 7 It is also used in navigation to find the shortest route.
- 8 By using the Pythagoras theorem, we can derive the formula for base, perpendicular and hypotenuse.
- 9 Painters use ladders to paint on high buildings with the help of the Pythagoras theorem.
- 10 Pythagoras theorem is used to calculate the steepness of slopes of hills or mountains.
- 11 The converse of the Pythagoras theorem is used to check whether a triangle is a right triangle or not.

Application of pythagoras theorem in real life

Pythagoras theorem states that

"In a right-angled triangle, the square of the hypotenuse side is equal to the sum of squares of the other two sides".

- 1 The sides of this triangle have been named Perpendicular, Base and Hypotenuse.
- 2 The hypotenuse is the longest side, as it is opposite to the angle 90°.

- 3 The sides of a right triangle (say AB, BC and CA) which have positive integer values, when squared, are put into an equation, also called a Pythagorean triplet.
- 4 To calculate the length of staircase required to reach a window
- 5 To find the length of the longest item can be kept in your room.
- 6 To find the steepness of the hills or mountains.
- 7 To find the original height of a tree broken due to heavy rain and lying on itself
- 8 To determine heights and measurements in the construction sites.

Examples

- 1 What is the side AC if AB = 15 cm, BC = 25 cm.

$$AC^2 = AB^2 + BC^2$$

$$= 15^2 + 25^2$$

$$= 225 + 625 = 850$$

$$AC = \sqrt{850} = 29.155 \text{ cm}$$

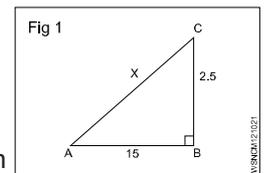

- 2 What is the side BC if AB = 10 cm, AC = 30 cm.

$$AC^2 = AB^2 + BC^2$$

$$30^2 = 10^2 + BC^2$$

$$900 = 100 + BC^2$$

$$BC^2 = 900 - 100 = 800$$

$$BC = 28.284 \text{ cm}$$

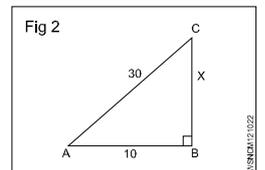

- 3 What is the side AB if BC = 20 cm, AC = 35 cm.

$$AC^2 = AB^2 + BC^2$$

$$35^2 = AB^2 + 20^2$$

$$1225 = AB^2 + 400$$

$$AB^2 = 1225 - 400 = 825$$

$$AB = 28.72 \text{ cm}$$

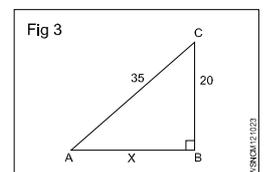

- 4 What is the value of side BC if AB = 8 cm, AC = 24 cm.

$$AC^2 = AB^2 + BC^2$$

$$24^2 = 8^2 + BC^2$$

$$576 = 64 + BC^2$$

$$BC^2 = 576 - 64 = 512$$

$$BC = \sqrt{512} = 22.63 \text{ cm}$$

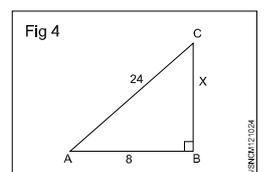

- 5 What is the value side AC if AB = 6.45 cm, BC = 8.52 cm.

$$\begin{aligned} AC^2 &= AB^2 + BC^2 \\ AC^2 &= 6.45^2 + 8.52^2 \\ AC^2 &= 41.60 + 72.59 \\ &= 114.19 \end{aligned}$$

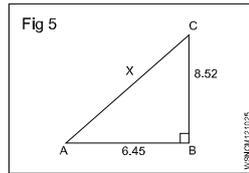

$$AC = \sqrt{114.19} = 10.69 \text{ cm}$$

- 6 What is the value of side AB if BC = 3.26 cm, AC = 8.24 cm.

$$\begin{aligned} AC^2 &= AB^2 + BC^2 \\ 8.24^2 &= AB^2 + 3.26^2 \\ 67.9 &= AB^2 + 10.63 \\ AB^2 &= 67.9 - 10.63 \\ &= 57.27 \end{aligned}$$

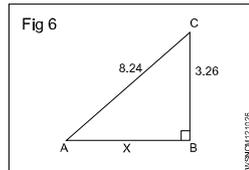

$$AB = \sqrt{57.27} = 7.57 \text{ cm}$$

- 7 What is the value of side AB if AC = 12.5 cm, BC = 8.5 cm.

$$\begin{aligned} AC^2 &= AB^2 + BC^2 \\ 12.5^2 &= AB^2 + 8.5^2 \\ 156.25 &= AB^2 + 72.25 \\ AB^2 &= 156.25 - 72.25 \\ &= 84 \\ AB &= \sqrt{84} = 9.17 \text{ cm} \end{aligned}$$

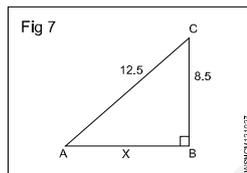

- 8 A ladder of 12.5 metre long is placed with upper end against a wall. The lower end being 7.5 metres from the wall. What height is the upper end above the ground.

$$\begin{aligned} AC^2 &= AB^2 + BC^2 \\ BC^2 &= AC^2 - AB^2 \\ BC^2 &= x^2 \\ AC^2 &= AB^2 + BC^2 \\ 12.5^2 &= x^2 + 7.5^2 \end{aligned}$$

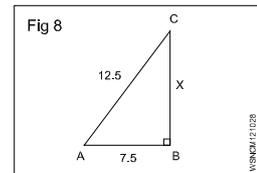

$$\begin{aligned} x^2 &= (12.5)^2 - (7.5)^2 \\ &= (12.5 + 7.5)(12.5 - 7.5)^2 \\ &= 20 \times 5 \\ &= \sqrt{100} = 10 \\ x &= 10 \text{ m} \end{aligned}$$

- 9 What is the value of AB.

$$\begin{aligned} AC^2 &= AB^2 + BC^2 \\ AB^2 &= AC^2 - BC^2 \\ AB^2 &= x^2 \\ AC^2 &= AB^2 + BC^2 \\ 10^2 &= x^2 + 6^2 \\ x^2 &= 10^2 - 6^2 \\ &= 100 - 36 = 64 \\ x &= \sqrt{64} \\ &= 8 \\ AB &= 8 \end{aligned}$$

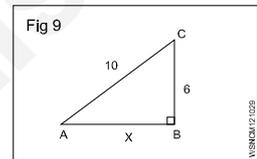

Assignment

- 1 What is the value of side AB, in a right angled triangle of side AC = 10 cm and BC = 5 cm.
- 2 What is the value of side AC, in a right angled triangle of side AB = 6.5 cm and BC = 4.5 cm.
- 3 What is the value of side BC, in a right angled triangle of side AC = 14.5 cm and AB = 10.5 cm.
- 4 What is the value of side AC, in a right angled triangle of side AB = 7 cm and BC = 5 cm.
- 5 What is the value of side BC, in a right angled triangle of side AC = 13.25 cm and AB = 8.75 cm.

Square root, Ratio and Proportions, Percentage - Ratio and proportion

Ratio

Introduction

It is the relation between two quantities of the same kind and is expressed as a fraction.

Expression

a, b two quantities of the same kind. $\frac{a}{b}$ or a:b or a ÷ b or

a in b is the ratio.

Ratio is always reduced to the lowest terms.

Example

$$7:14 = \frac{7}{14} = \frac{1}{2} = 1:2$$

Proportion

It is the equality between the ratios, a : b is a ratio and c : d is another ratio. Both ratios are equal. Then

$$a : b :: c : d \text{ or } \frac{a}{b} = \frac{c}{d}$$

Example

$$250 : 2000 :: 1 : 8$$

Proportion fundamentals

If $\frac{a}{b} = \frac{c}{d}$ then

- $ad = bc$

- $\frac{a}{c} = \frac{b}{d}$

- $\frac{b}{a} = \frac{d}{c}$

- $\frac{a+b}{b} = \frac{c+d}{c}$ and $\frac{a+b}{a} = \frac{c+d}{d}$

- $\frac{a-b}{b} = \frac{c-d}{d}$

- $\frac{a+b}{b+d} = \frac{a}{c} = \frac{c}{d}$

$$3:4::6:8 \text{ or } \frac{3}{4} = \frac{6}{8}$$

- $3 \times 8 = 6 \times 4$

- $\frac{3}{6} = \frac{4}{8}$

- $\frac{4}{3} = \frac{8}{6}$

- $\frac{3+4}{4} = \frac{6+8}{8}$

- $\frac{3-4}{4} = \frac{6-8}{8}$

- $\frac{3+6}{4+8} = \frac{9}{12} = \frac{3}{4}$

**Ratio - relation of two quantities of the same kind.
Proportion - equality between two ratios.**

Example

- A steel plate of 800 x 1400 mm is to be drawn to a scale of 1:20. What will be the lengths in the Fig 1.

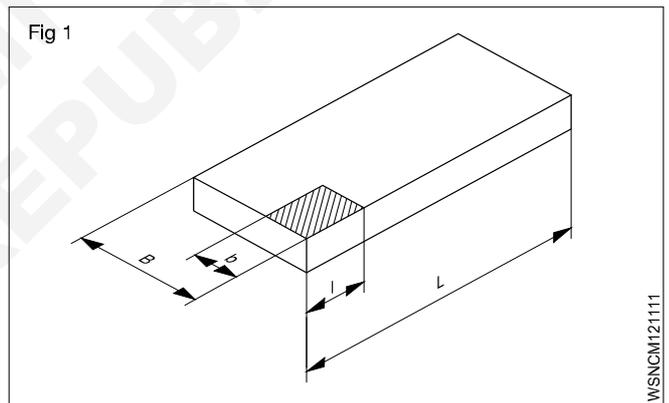

The reduction ratio is $\frac{1}{20}$.

B is reduced from 800 to $800 \times \frac{1}{20} = 40$ mm.

L is reduced from 1400 to $1400 \times \frac{1}{20} = 70$ mm.

- Find the number of teeth of the larger gear in the gear transmission shown in the Fig 2.

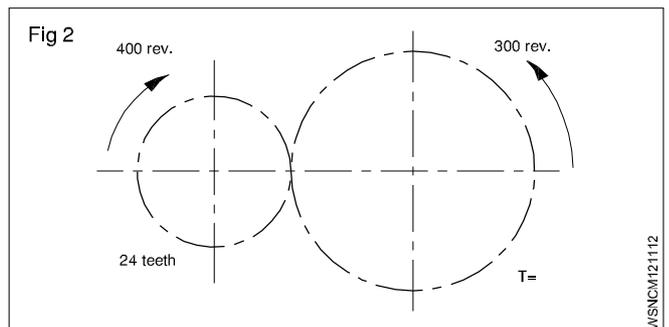

Square root, Ratio and Proportions, Percentage - Ratio and Proportions - Direct and indirect proportions

Proportion

Description

It is the equality between the ratios, a:b is a ratio and c:d is another ratio. Both ratios are equal. Then

$a : b :: c : d$ or e.g. $250 : 2000 :: 1 : 8$

Rule of three

A three step calculation

statement

single

multiple.

Direct proportion

The more in one the more in the other - An increase in one denomination produces an increase in the other. (Fig 1)

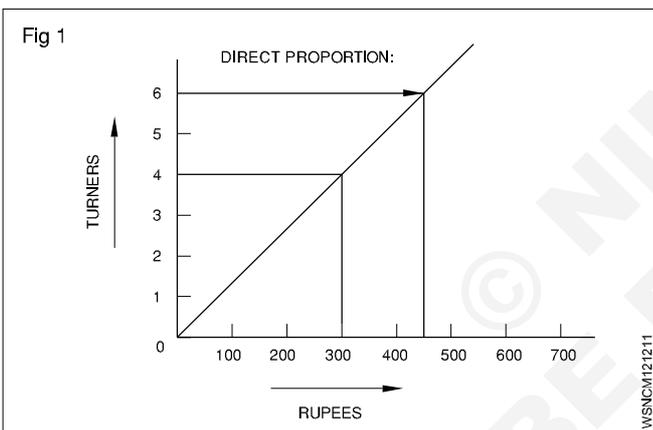

Examples

- 1 4 turners earn 300 Rupees. How much will 6 Turners earn?

Statement

4 turners = 300 Rupees

Single

1 Turner = 75 Rupees

Multiple

6 Turners = $6 \times 75 = 450$ Rupees

- 2 One vehicle consumes 30 litres of petrol per day how much petrol is used by 6 Vehicles operating under similar condition.

One vehicle uses petrol = 30 litres per day.

Then six vehicles will use = 6 Times as much

= $6 \times 30 = 180$ litres/day.

- 3 4 vehicles consumes 120 gallons of petrol per day how much petrol will be used by 12 vehicles operating under the same condition.

4 vehicles use 120 gallons per day

1 Vehicle will use $\frac{120}{4} = 30$ gallons/day

12 vehicles will use $12 \times 30 = 360$ gallons/day

Both examples are called simple proportion because only two quantities were used and the day is common for both ratios.

- 4 If 2 litres of petrol costs Rs 60. Find the cost of 50 litres.

Quantity of Petrol	Cost of Petrol
--------------------	----------------

2 litres	Rs.60
----------	-------

50 litres	x
-----------	-----

1 litre petrol = $\frac{60}{2} = \text{Rs.}30$

50 litres petrol = $30 \times 50 = \text{Rs } 1500$

- 5 A 150mm dia gear meshes with 50mm dia gear. If the larger gear has 30 teeth. How many teeth will have the smaller gear have?

Gear dia	No. of Teeth
----------	--------------

150 mm	30
--------	----

50 mm	x
-------	-----

$x = \frac{50}{150} \times 30 = 10$ teeth.

- 6 A mechanic assembles 7 machines in 2½ days. How long will it take time to assemble 70 machines at the same rate.

Machines	Days
----------	------

7	2½
---	----

70	x
----	-----

$x = \frac{70 \times 2.5}{7} = 25$ days

Assemble for 70 machines will take 25 days.

- 7 A roll of wire weighs 1.24 kg from this roll a piece of 3.7cm long is cut and it is found to weigh 2.93 gm. What is the length of the wire in the roll?

Weight of wire	Length of wire
----------------	----------------

2.93 gm	3.7 cm
---------	--------

1.24 kg (1240 gm)	x
-------------------	-----

$$x = \frac{1240}{2.93} \times 3.7 = 1566 \text{ cm}$$

Length of wire = 1566 cm.

Indirect or inverse proportion

The more in one the lesser other - Increase in one quantity will produce a decrease in the other. (Fig 2)

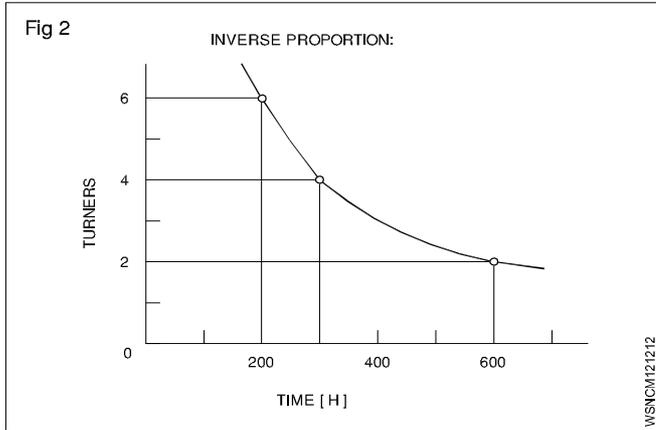

Example

- 1 4 turners finish a job in 300 hours. How much time will 6 turners take to do the same job?

Solution procedure in three steps:

Statement 4 turners taken = 300 hours

The time will reduce if 6 turners to do the same job. Therefore this is inverse proportion.

Multiple fraction $\frac{4 \text{ Turners}}{6 \text{ Turners}} \times 300 \text{ hours}$

6 Turners = 200 hours

Result - The more the less.

- 2 8 workman take 6 days to complete a job. How many days it will take for 4 workman to complete the same job?

Workman	Days
8	6
4	x

$$x = \frac{8}{4} \times 6 = 12 \text{ days}$$

4 workers complete the work = 12 days.

- 3 5 men working on a job finished it in 32 days. Find out in how many days 8 men will finish the same job?

Men	Days
5	32
8	x

$$x = \frac{5 \times 32}{8} = 4 \times 5 = 20 \text{ days}$$

8 men will complete the job = 20 days.

- 4 An engine running at 150 rpm drives a shaft by pulley diameter is 55cm and that of the driven shaft pulley is 33 cm. Find the speed of the shaft?

Dia of pulley	Rpm of shaft
55 cm	150
33 cm	x

$$x = \frac{55 \times 150}{33} = 250 \text{ rpm.}$$

Speed of the 33cm diameter will run 250 rpm.

- 5 A pulley of 80 cm diameter is rotating at 100 rpm and drives another pulley of 40 cm diameter. Find the rpm of driven pulley. If slip is 2.5% find the rpm?

Dia of pulley	Rpm of pulley
80 cm	100
40 cm	x

40 cm diameter = 200 rpm.

Slip is 2.5% = 195 rpm.

Problems involving both

Example

2 turners need 3 days to produce 20 pieces. How long will it take for 6 turners to produce 30 such pieces?

Statement

2 turners, 20 pieces = 3 days

6 turners, 30 pieces = how many days.

First step (Fig 3)

Statement 2 turners for 20 pieces = 3 days

1 turner for 20 pieces = $3 \times 2 = 6$ days

Multiple 6 turners for 20 pieces = $\frac{6}{6} = 1$ day

Statement 6 turners for 20 pieces = 1 day

Single 6 turners for 1 piece = $\frac{1}{20}$ days

Multiple 6 turners for 30 pieces = $\frac{1}{20} \times 30 = 1.5$ days

Inverse proportion - More the less.

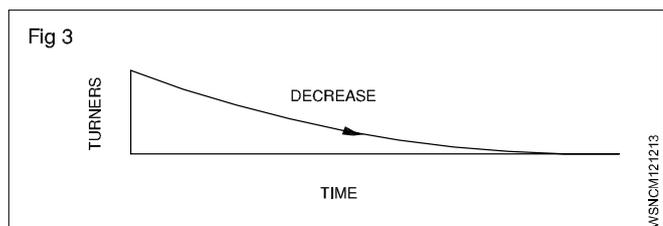

Second step (Fig 4)

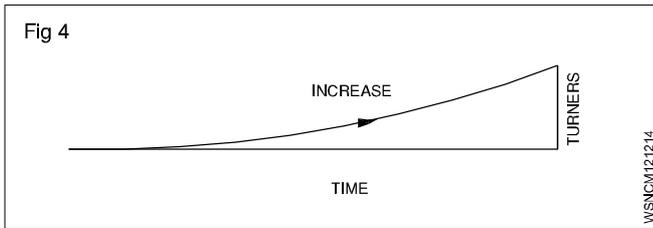

Direct proportion - More the more.

Solve the problem by first writing the statement and proceed to single and then to the multiple according to the type of proportion that is involved.

Introduction

Proportional fundamentals, as applicable to motor vehicle calculations are discussed below.

Simple Proportion

- Proportion

This is an equality between two ratios

Compound and Inverse proportions

- Compound proportions

Example

5 Fitter take 21 days to complete overhauling of 6 vehicles how long 7 Fitters will take to over haul 8 vehicles (Assume time of overhauling each vehicle is constant)

In this both direct and indirect proportions are used.

- 1 Fitter will overhauling 1 vehicle in days (shorter time).
- Quantities (No. of days) are taken in last as that is the answer required in this case.

Fitters	Vehicle	Days
5	6	21
7	8	x

$$\left(\frac{21 \times 5}{6 \times 7} \times 8\right) = 20 \text{ days}$$

Ans: 7 Fitters will overhaul 8 vehicles in 20 days.

Inverse proportion

Some times proportions are taken inversely.

Examples

- If one water pump fills the fuel tank in 12 minutes, two pumps will take half the time taken.

The time should not be doubled.

- 2 pumps will take 30 minutes to fill up a tank how long will 6 similar pumps take this to fill this tank.

Pump	Time
2	30
6	x

Ans: Time taken by 6 pumps = $\frac{30 \times 2}{6} = 10 \text{ minutes}$

Assignment

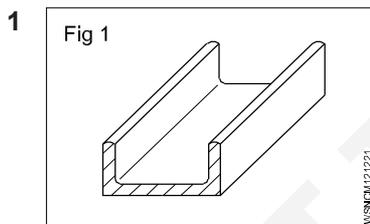

Length = 6.1 metre
Weight = 32 kgf
Weight of 1 metre of the same channel = _____ kgf

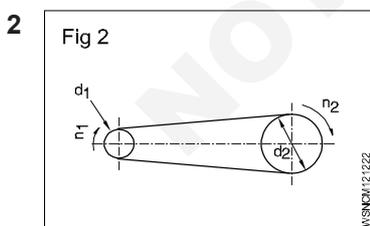

d₁ = 120 mm
d₂ = 720 mm
n₁ = 1200 rpm
n₂ = _____ rpm

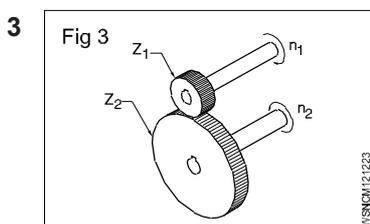

Z₁ = 42 T
n₂ = 96 rpm
n₁ = 224 rpm
Z₂ = _____ T

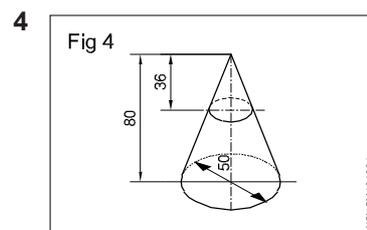

D = 50 mm
H = 80 mm
h = 36 mm
d = _____ mm

- If a mechanic assembles 8 machines in 3 days, how long he will take to assemble 60 machines.
- In an auto shop the grinding wheel makes 1000 rpm and the driven pulley is 200 mm dia. If the driving pulley is 150 mm dia. Find out the rpm of the driving pulley.
- In a gearing of a vehicle the following facts are found. A 180 mm dia of gear meshes with 60mm dia gear. If the bigger gear makes 60 rpm. What will be the rpm of smaller gear.
- A vehicular job is completed by 5 mechanics in 4 days. If only 3 mechanics are available, in how many days the work can be completed.

Square root, Ratio and Proportions, Percentage - Percentage

Percentage

Percentage is a kind of fraction whose denominator is always 100. The symbol for percent is %, written after the number. e.g. 16%.

Ex. $\frac{16}{100} = 0.16$

In decimal form, it is 0.16. Percentage calculation also involves rule of three. The statement (the given data), for unit, and then to multiple which is for calculating the answer. (Fig 1)

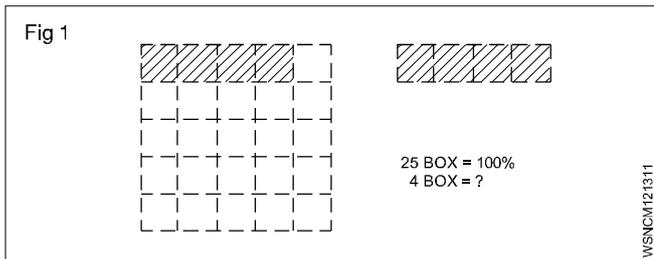

Example

The amount of total raw sheet metal to make a door was 3.6 metre² and wastage was 0.18 metre². Calculate the % of wastage. (Fig 2)

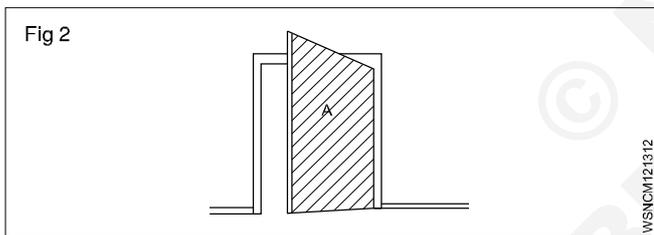

Solution procedure in three steps.

Statement:

Area of door (A) = 3.6 m² = 100 %.

Wastage = 0.18 m²

Single: $\frac{100}{3.6} \times 1 \text{ m}^2$

Multiple: for 0.18 m² = $\frac{100}{3.6} \times 0.18$.

Wastage = 5%.

Analyse the given data and proceed to arrive at the answer through the unit.

Example

A fitter receives a take-home salary of 984.50 rupees.

If the deduction amounts to 24%, what is his total salary? (Fig 3)

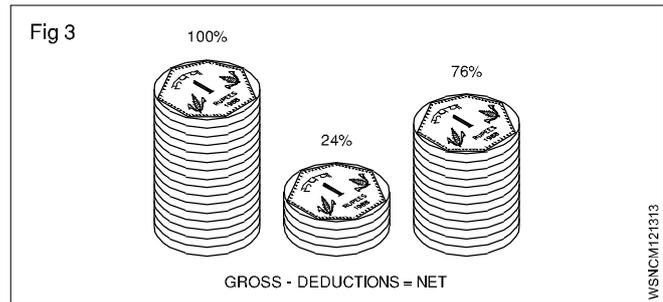

Total pay 100%

Deduction 24%

Take home salary 76%

If the take home pay is Rs.76, his salary is 100.

For 1% it is $\frac{1}{76}$

For Rs.984.50, it is $\frac{1}{76} \times 984.50$.

For 100% it is $\frac{984.50}{76} \times 100 = 1295.39$

100% i.e. gross pay = Rs.1295.40.

Example 1

75 litres of oil is taken out from a oil barrel of 200 litres capacity. Find out the percentage taken in this.

Solution

% of oil taken = Oil taken out (litres) / Capacity of Barrel (litres) x 100

$= \frac{75}{200} \times 100 = 37\frac{1}{2}\%$

Example 2

A spare part is sold with 15%. Profit to a customer, to a price of Rs.15000/-. Find out the following (a) What is the purchase price (b) What is the profit.

Solution: CP = x ,

CP = cost price

SP = sale price

SP=CP+15%of CP

$15000 = x + \frac{15x}{100} = \frac{100x + 15x}{100}$

$x = \frac{1500000}{115} = 13043.47$

Profit = SP-CP = 15000-13043.47 = 1956.53

Purchase price = Rs.13,043/, Profit = Rs. 1957

Example 3

Out of 80000 cars, which were tested on road, only 16000 cars had no fault. What is the percentage in this acceptance.

$$= \frac{16000}{80000} \times 100 = \frac{100}{5} = 20\%$$

Example 4

The price of a motor cycle dropped to 92% of original price and now sold at Rs. 18000/- What was the original price.

Solution

Present price of Motor cycle Rs. 18000

This is the value of 92% of original price

$$\begin{aligned} \text{Original Price} &= 18000 \times \frac{100}{92} = \frac{1800000}{92} \\ &= \text{Rs. } 19565 \end{aligned}$$

Example 5

A Motor vehicle uses 100 litres of Petrol per day when travelling at 30 kmph. After top overhauling the consumption falls to 90 litres per day. Calculate percentage of saving.

Solution

Percentage of saving = Decrease in consumption / Original consumption x 100

$$= (100 - 90) \frac{\text{litres}}{100} \times 100$$

$$= \frac{10}{100} \times 100$$

= 10% Saving in fuel.

Assignment

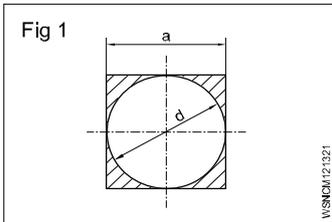
- 

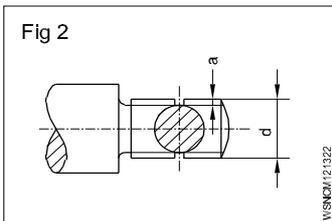
a = 400mm (side of square)
d = 400 mm
Wastage = _____ %.
- 

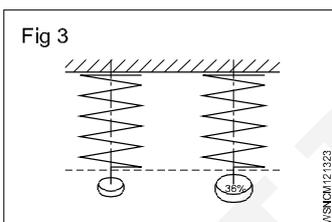
d = 26mm
'a' depth of u/cut = 2.4mm
reduction of area at cross-section = _____ %
- 

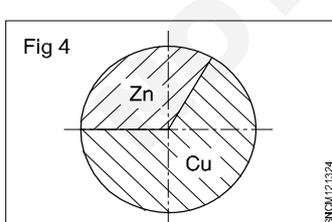
Percentage of increase = 36%
Value of increase = 611.2 N/mm²
Original tensile strength = _____ N/mm².
- 

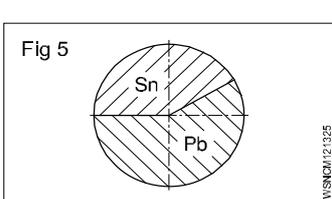
Copper in alloy = 27 kg
Zinc in alloy = 18 kg
% of Copper = _____ %
% of Zinc = _____ %.
- 

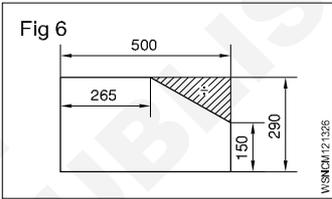
Weight of alloy = 140 Kgf
Weight of Sn 40%
Pb = _____ Kgf
Sn = _____ Kgf.
- 

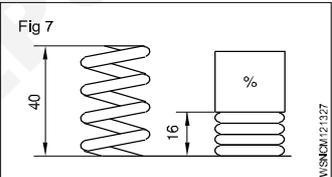
Shaded portion = _____ %.
- 

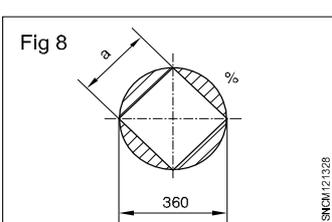
Compression length = _____ %.
- 

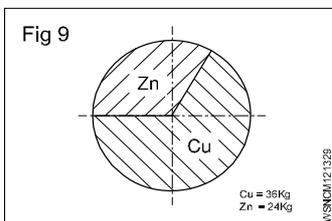
d = 360 mm
a = 0.707 x d
Wastage = _____ %.
- 

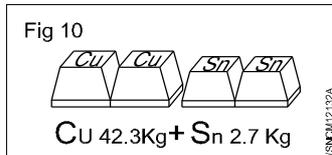
Cu = 36 Kg
Zn = 24 Kg
Cu = _____ %
Zn = _____ %
- 

Cu = 42.3 Kg
Sn = 2.7 Kg
Cu _____ %
Sn = _____ %.

Square root, Ratio and Proportions, Percentage - Changing percentage to decimal and fraction**Conversion of Fraction into Percentage**

1 Convert $\frac{1}{2}$ into percentage.

$$\text{Solution: } \frac{1}{2} \times 100 \\ = 50\%$$

2 Convert $\frac{1}{11}$ into percentage

$$\text{Solution: } \frac{1}{11} \times 100 = \frac{100}{11} \\ = 9.01\%$$

Convert the following fraction into percentage.

1 $\frac{1}{4}$

2 $\frac{1}{5}$

3 $\frac{2}{3}$

4 $\frac{3}{8}$

Conversion of Percentage into Fraction

1 Convert 24% into fraction.

$$\text{Solution: } \frac{24}{100} = \frac{6}{25}$$

2 Convert $33\frac{1}{3}\%$ into fraction.

$$\text{Solution: } \frac{33\frac{1}{3}}{100} = \frac{\frac{100}{3}}{100} = \frac{100}{3} \times \frac{1}{100} \\ = \frac{1}{3}$$

Convert the following percentage into fraction

1 15%

2 $87\frac{1}{2}\%$

3 80%

4 12.5%

Conversion of Decimal Fraction into Percentage

1 Convert 0.35 into percentage.

$$\text{Solution: } 0.35 \times 100 \\ = 35\%$$

2 Convert 0.375 into percentage.

$$\text{Solution: } 0.375 \times 100 \\ = 37.5\%$$

Convert the following Decimal Fraction into Percentage

1 0.2

2 0.004

3 0.875

4 0.052

Conversion of Percentage into Decimal fraction

1 Convert 30% into decimal fraction.

$$\text{Solution: } \frac{30}{100} = 0.3$$

2 Convert $33\frac{1}{3}\%$ into decimal fraction.

$$\text{Solution: } \frac{33\frac{1}{3}}{100} = \frac{\frac{100}{3}}{100} = \frac{100}{3} \times \frac{1}{100} \\ = \frac{1}{3} = 0.333$$

Convert the following percentage into decimal fraction

1 15%

2 7%

3 $12\frac{1}{2}\%$

4 90%

Material science - Types of metal, types of ferrous and non ferrous metals

Types of metals

The metals is of two types:

- 1 Ferrous metal
- 2 Non-ferrous metal

1 Ferrous metals : The metals that contains major part of iron and contain carbon are called ferrous metals such as pig iron, mild steel, nickel etc., they have iron properties such as rusting, magnetisations etc.

2 Non-ferrous metals : The metals that do not contains iron or carbon and do not have the property of iron are called non-ferrous metals such as copper, aluminum etc.

Ferrous and Non ferrous alloys

Alloying metals and ferrous alloys

An alloy is formed by mixing two or more metals together by melting.

For ferrous metals and alloys, iron is the main constituent metal. Depending on the type and percentage of the alloying metal added, the property of the alloy steel will vary.

Metals commonly used for making alloy steels

Nickel (Ni)

This is a hard metal and is resistant to many types of corrosion rust.

It is used in industrial applications like nickel, cadmium batteries, boiler tubes, valves of internal combustion engines, engine spark plugs etc. The melting point of nickel is 1450°C. Nickel can be magnetised. In the manufacture of permanent magnets a special nickel steel alloy is used. Nickel is also used for electroplating. Invar steel contains about 36% nickel. It is tough and corrosion resistant. Precision instruments are made of Invar steel because it has the least coefficient of expansion.

Nickel-steel alloys are available containing nickel from 2% to 50%.

Chromium (Cr)

Chromium, when added to steel, improves the corrosion resistance, toughness and hardenability of steel. Chromium steels are available which may contain chromium up to 30%.

Chromium, nickel, tungsten and molybdenum are alloyed for making automobile components and cutting tools.

Chromium is also used for electroplating components. Cylinder liners are chrome-plated inside so as to have wear resistance properties. Stainless steel contains about 13% chromium. Chromium-nickel steel is used for bearings. Chrome-vanadium steel is used for making hand tools like spanners and wrenches.

Manganese (Mn)

Addition of manganese to steel increases hardness and strength but decreases the cooling rate.

Manganese steel can be used to harden the outer surface for providing a wear resisting surface with a tough core. Manganese steel containing about 14% manganese is used for making agricultural equipment like ploughs and blades.

Silicon (Si)

Addition of silicon for alloying with steel improves resistance to high temperature oxidation.

This also improves elasticity, and resistance against corrosion. Silicon alloyed steels are used in manufacturing springs and certain types of steel, due to its resistance to corrosion. Cast iron contains silicon about 2.5%. It helps in the formation of free graphite which promotes the machinability of cast iron.

Tungsten (W)

The melting temperature of tungsten is 3380° C. This can be drawn into thin wires.

Due to this reason it is used to make filaments of electric lamps.

Tungsten is used as an alloying metal for the production of high speed cutting tools. High speed steel is an alloy of 18% tungsten, 4% chromium and 1% vanadium.

Stellite is an alloy of 30% chromium, 20% tungsten, 1 to 4% carbon and the balance cobalt.

Vanadium (Va)

This improves the toughness of steel. Vanadium steel is used in the manufacture of gears, tools etc. Vanadium helps in providing a fine grain structure in tool steels.

Chrome-vanadium steel contains 0.5% to 1.5% chromium, 0.15% to 0.3% vanadium, 0.13% to 1.10% carbon.

This alloy has high tensile strength, elastic limit and ductility. It is used in the manufacture of springs, gears, shafts and drop forged components.

Vanadium high speed steel contains 0.70% carbon and about 10% vanadium. This is considered as a superior high speed steel.

Cobalt (Co)

The melting point of cobalt is 1495°C. This can retain magnetic properties and wear- resistance at very high temperatures. Cobalt is used in the manufacture of magnets, ball bearings, cutting tools etc. Cobalt high speed steel (sometimes known as super H.S.S.) contains about 5 to 8% cobalt. This has better hardness and wear resistance properties than the 18% tungsten H.S.S.

Molybdenum (Mo)

The melting point of molybdenum is 2620°C. This gives high resistance against softening when heated. Molybdenum high speed steel contains 6% of molybdenum, 6% tungsten, 4% chromium and 2% vanadium. This high speed steel is very tough and has good cutting ability.

Cadmium (cd)

The melting point of cadmium is 320°C. This is used for coating steel components.

Alloying Metals and Non Ferrous Alloys

Non-ferrous Metals And Alloys

Copper and its alloys

Metals without iron are called non-ferrous metals. Eg. Copper, Aluminium, Zinc, Lead and Tin.

Copper

This is extracted from its ores 'MALACHITE' which contains about 55% copper and 'PYRITES' which contains about 32% copper.

Properties

Reddish in colour. Copper is easily distinguishable because of its colour.

The structure when fractured is granular, but when forged or rolled it is fibrous.

It is very malleable and ductile and can be made into sheets or wires.

It is a good conductor of electricity. Copper is extensively used as electrical cables and parts of electrical apparatus which conduct electric current.

Copper is a good conductor of heat and also highly resistant to corrosion. For this reason it is used for boiler fire boxes, water heating apparatus, water pipes and vessels in brewery and chemical plants. Also used for making soldering iron.

The melting temperature of copper is 1083°C.

The tensile strength of copper can be increased by hammering or rolling.

Copper Alloys

Brass

It is an alloy of copper and zinc. For certain types of brass small quantities of tin or lead are added. The colour of brass depends on the percentage of the alloying elements. The colour is yellow or light yellow, or nearly white. It can be easily machined. Brass is also corrosion-resistant.

Brass is widely used for making motor car radiator core and water taps etc. It is also used in gas welding for hard soldering/brazing. The melting point of brass ranges from 880 to 930°C.

Brasses of different composition are made for various applications.

Bronze

Bronze is basically an alloy of copper and tin. Sometimes zinc is also added for achieving certain special properties. Its colour ranges from red to yellow. The melting point of bronze is about 1005°C. It is harder than brass. It can be easily machined with sharp tools. The chip produced is granular. Special bronze alloys are used as brazing rods.

Bronze of different compositions are available for various applications.

Lead and its alloys

Lead is a very commonly used non-ferrous metal and has a variety of industrial applications.

Lead is produced from its ore 'GALENA'. Lead is a heavy metal that is silvery in colour when molten. It is soft and malleable and has good resistance to corrosion. It is a good insulator against nuclear radiation. Lead is resistant to many acids like sulphuric acid and hydrochloric acid.

It is used in car batteries, in the preparation of solders etc. It is also used in the preparation of paints.

Lead Alloys

Babbitt metal

Babbitt metal is an alloy of lead, tin, copper and antimony. It is a soft, anti-friction alloy, often used as bearings.

An alloy of lead and tin is used as 'soft solder'.

Zinc and its alloys

Zinc is a commonly used metal for coating on steel to prevent corrosion. Examples are steel buckets, galvanized roofing sheets, etc.

Zinc is obtained from the ore-calamine or blende.

Its melting point is 420° C.

It is brittle and softens on heating; it is also corrosion-resistant. Due to this reason it is used for battery containers and is coated on roofing sheets etc.

Galvanized iron sheets are coated with zinc.

Tin and tin alloys

Tin

Tin is produced from cassiterite or tinstone. It is silvery white in appearance, and the melting point is 231° C. It is soft and highly corrosion-resistant.

It is mainly used as a coating on steel sheets for the production of food containers. It is also used with other metals, to form alloys.

Example: Tin with copper to form bronze. Tin with lead to form solder. Tin with copper, lead and antimony to form Babbitt metal.

Aluminium

Aluminium is a non-ferrous metal which is extracted from 'BAUXITE'. Aluminium is white or whitish grey in colour. It has a melting point of 660° C. Aluminium has high electrical and thermal conductivity. It is soft and ductile, and has low tensile strength. Aluminium is very widely used in aircraft industry and fabrication work because of its lightness. Its application in the electrical industry is also on the increase. It is also very much in use in household heating appliances.

Material science - Physical and mechanical properties of metals

Metal:

Metal is a mineral used in all types of engineering works such as machineries, bridges, aero planes etc., so we must have basic knowledge about the metals.

Understanding the physical and mechanical properties of metals has become increasingly important for a machinist since he has to make various components to meet the designed service requirements against factors, such as the raise of temperature, tensile, compressive and impact loads etc. A knowledge of different properties of materials will help him to do his job successfully. If proper material/metal is not used it may cause fracture or other forms of failures, and endanger the life of the component when it is put into function.

Fig 1 shows the way in which the metals get deformed when acted upon by the same load.

Note the difference in the amount of deformation.

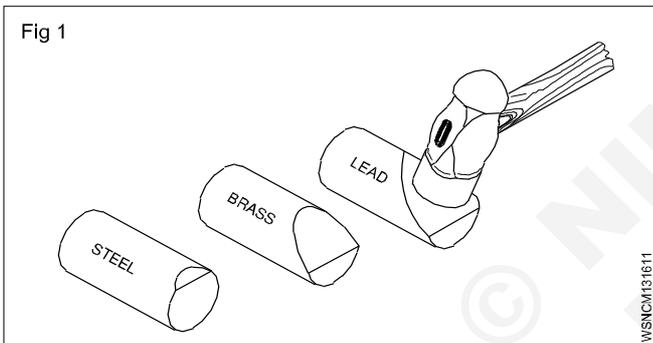

Physical properties of metals

- Colour
- Weight/specific gravity
- Structure
- Conductivity
- Magnetic property
- Fusibility

Colour

Different metals have different colours. For example, copper is distinctive red colour. Mild steel is blue/black sheen.

Weight

Metals may be distinguished, based on their weights for given volume. Metals like aluminium lighter weight (Specific gravity 2.7) and metals like lead have a higher weight. (Specific gravity 11.34)

Structure (Figs 2&3)

Generally metals can also be differentiated by their internal structures while seeing the cross-section of the bar through a microscope. Metals like wrought iron and aluminium have a fibrous structure and metals like cast Iron and bronze have a granular structure.

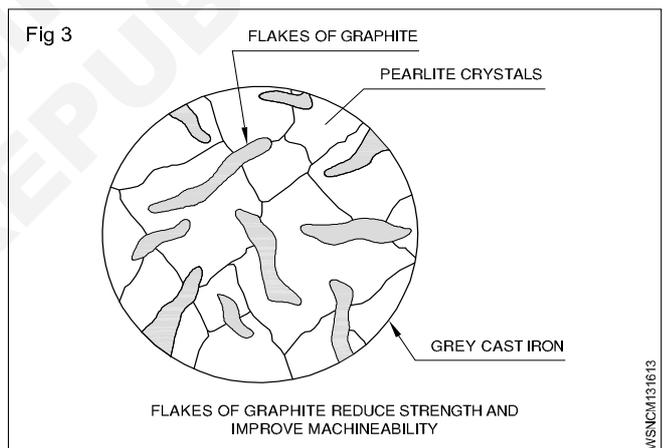
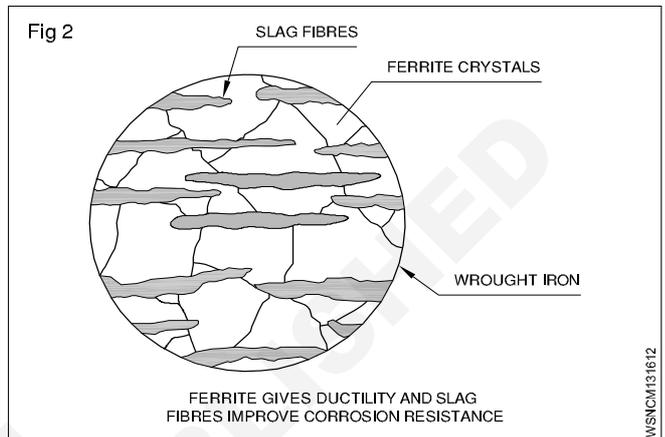

Conductivity (Figs 4&5)

Thermal conductivity and electrical conductivity are the measures of ability of a material to conduct heat and electricity. Conductivity will vary from metal to metal. Copper and aluminium are good conductors of heat and electricity.

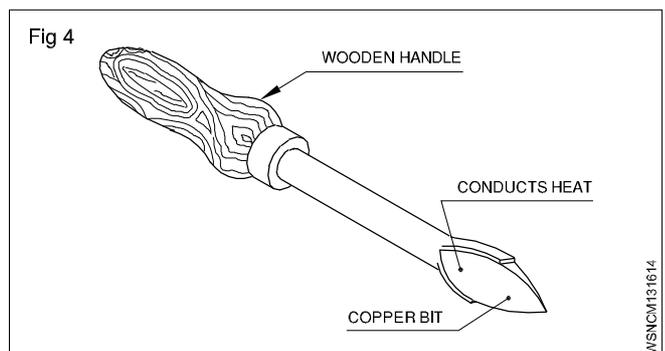

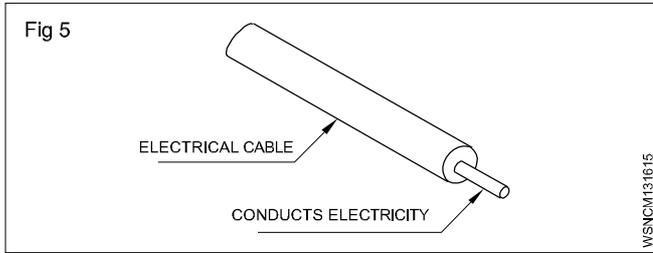

Magnetic property

A metal is said to possess a magnetic property if it is attracted by a magnet.

Almost all ferrous metals, except some types of stainless steel, can be attracted by a magnet, and all non-ferrous metals and their alloys are not attracted by a magnet.

Fusibility (Fig 6)

It is the property possessed by a metal by virtue of which it melts when heat is applied. Many materials are subject to transformation in the shape (i.e) from solid to liquid at different temperatures. Lead has a low melting temperature while steel melts at a high temperature.

Tin melts at 232°C.

Tungsten melts at 3370°C.

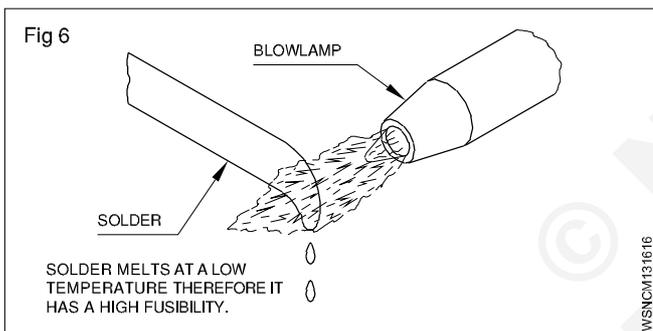

Mechanical properties

- Ductility
- Malleability
- Hardness
- Brittleness
- Toughness
- Tenacity
- Elasticity

Ductility (Fig 7)

A metal is said to be ductile when it can be drawn out into wires under tension without rupture. Wire drawing depends upon the ductility of a metal. A ductile metal must be both strong and plastic. Copper and aluminium are good examples of ductile metals.

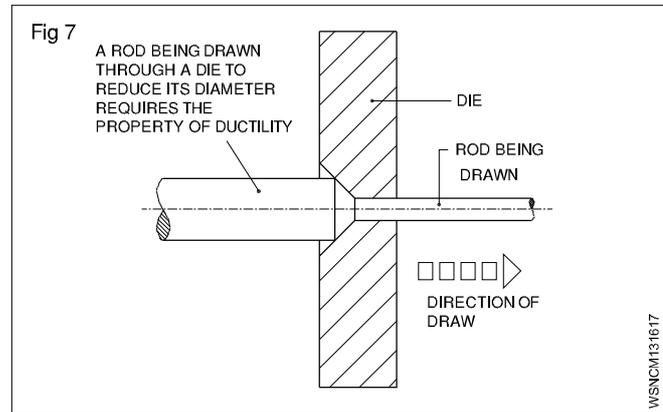

Malleability (Figs 8 and 9)

Malleability is the property of a metal by which it can be extended in any direction by hammering, rolling etc. without causing rupture. Lead is an example of a malleable metal.

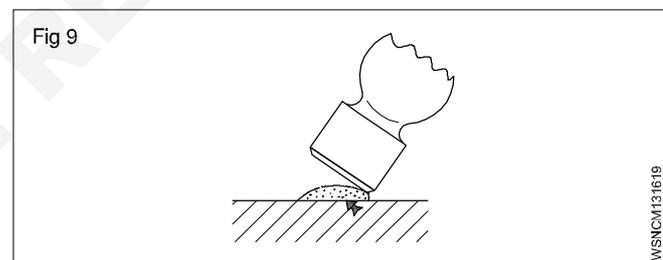
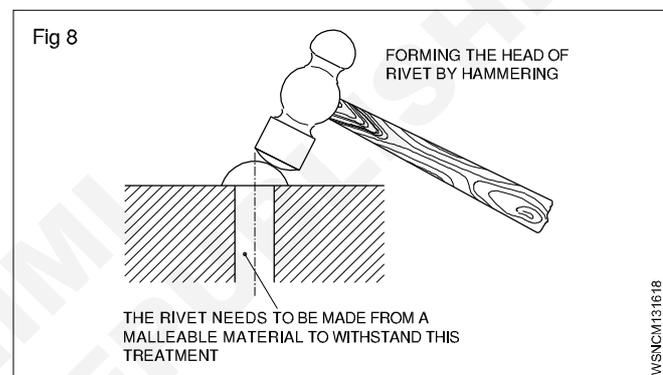

Hardness (Fig 10)

Hardness is a measure of a metal's ability to withstand scratching, wear and abrasion, indentation by harder bodies. The hardness of a metal is tested by marking by a file etc.

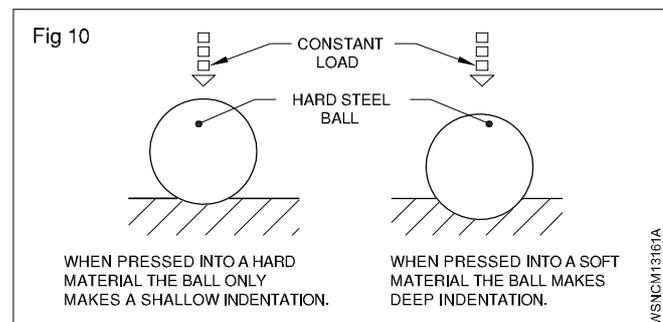

Brittleness (Fig 11)

Brittleness is that property of a metal which permits no permanent distortion before breaking. Cast iron is an example of a brittle metal which will break rather than bend under shock or impact.

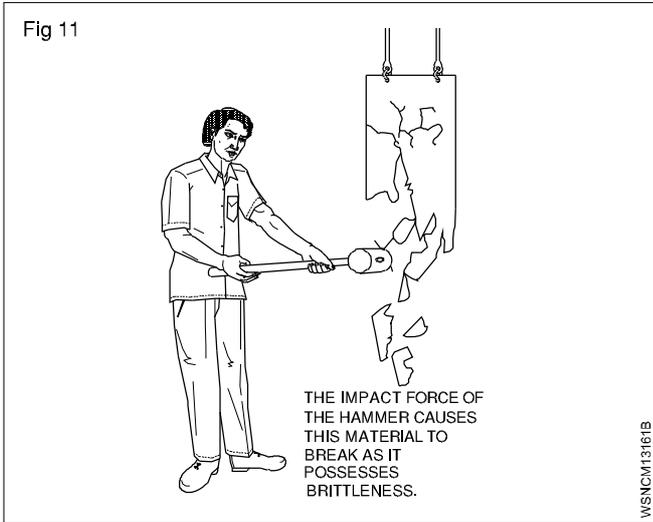

Toughness (Fig 12)

Toughness is the property of a metal to withstand shock or impact. Toughness is the property opposite to brittleness. Wrought iron is an example of a tough metal.

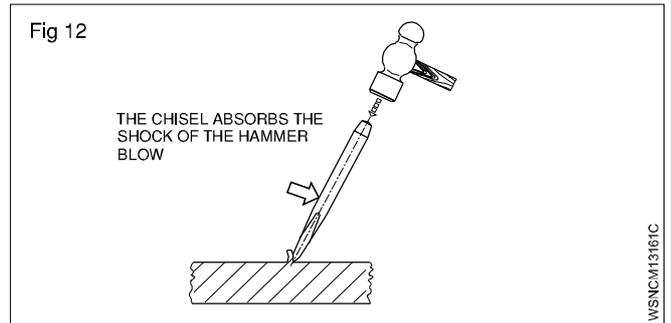

Tenacity

The tenacity of a metal is its ability to resist the effect of tensile forces without rupturing. Mild steel, Wrought Iron and copper are some examples of tenacious metals.

Elasticity

Elasticity of a metal is its power of returning to its original shape after the applied force is released. Properly heat-treated spring is a good example for elasticity.

Material science - Introduction of iron and cast iron

Ferrous Metals

Metals which contain iron as a major content are called ferrous metals. Ferrous metals of different properties are used for various purposes.

Introduction of Iron, Cast Iron, wrought Iron and steel

The ferrous metals and alloys used commonly are:

- Pig-iron
- Cast Iron
- Wrought Iron
- Steels and Alloy steels

Different processes are used to produce iron and steel.

Pig-iron (Manufacturing process)

Pig-iron is obtained by the chemical reduction of iron ore. This process of reduction of the iron ore to Pig-iron is known as SMELTING.

The main raw materials required for producing Pig-iron are:

- Iron ore
- Coke
- Flux

Iron ore

The chief iron ores used are:

- magnetite
- hematite
- limonite
- carbonite.

These ores contain iron in different proportions and are naturally available.

Coke

Coke is the fuel used to give the necessary heat to carry on the reducing action. The carbon from the coke in the form of carbon monoxide combines with the iron ore to reduce it to iron.

Flux

This is the mineral substance charged into a blast furnace to lower the melting point of the ore, and it combines with the non-metallic portion of the ore to form a molten slag.

Limestone is the most commonly used flux in the blast furnace.

Properties and use of Pig-iron

Pig-iron is, therefore, refined and remelted and used to produce other varieties of iron and steel.

Cast Iron (Manufacturing process)

The pig-iron which is tapped from the blast furnace is the crude form of raw material for the cupola, and should be further refined for making castings. This refining is carried out in the cupola furnace which is a small form of a blast furnace.

Generally cupolas are not worked continuously like blast furnaces but are run only as and when required.

Cast Iron (Types)

Cast iron is an alloy of iron, carbon and silicon. The carbon content ranges from 2 to 4%.

Types of cast iron

The following are the types of cast iron.

- Grey cast iron
- White cast iron
- Malleable cast iron
- Nodular cast iron

Grey cast iron

This is widely used for the casting of machinery parts and can be machined easily.

Machine base, tables, slideways are made of cast iron because it is dimensionally stable after a period of aging.

Because of its graphite content, cast iron provides an excellent bearing and sliding surface.

The melting point is lower than that of steel and as grey cast iron possesses good fluidity, intricate casting can be made.

Grey cast iron is widely used for machine tools because of its ability to reduce vibration and minimize tool chatter.

Grey cast iron, when not alloyed, is quite brittle and has relatively low tensile strength. Due to this reason it is not used for making components subjected to high stress or impact loads.

Grey cast iron is often alloyed with nickel, chromium, vanadium or copper to make it tough.

Grey cast iron is weldable but the base metal needs preheating.

White cast iron

This is very hard and is very difficult to machine, and for this reason, it is used in components which should be abrasion-resistant.

White cast iron is produced by lowering the silicon content and by rapid cooling. When cooled in this manner, it is called chilled cast iron.

White cast iron cannot be welded.

Malleable cast iron

Malleable cast iron has increased ductility, tensile strength and toughness when compared with grey cast iron.

Malleable cast iron is produced from white cast iron by a prolonged heat-treatment process lasting for about 30 hours.

Nodular cast iron

This is very similar to malleable cast iron. But this is produced without any heat treatment. Nodular cast iron is also known as: **Nodular Iron - Ductile Iron - Spheroidal Graphite Iron**

This has good machinability, castability, resistance to wear, low melting point and hardness.

Malleable and nodular castings are used for machine parts where there is a higher tensile stress and moderate impact loading. These castings are less expensive and are an alternative to steel castings.

Wrought Iron (Manufacturing process) (Fig 1)

Wrought iron is the purest form of iron. The analysis of Wrought iron shows as much as 99.9% of iron. (Fig 1) When heated, wrought iron does not melt, but only becomes pasty and in this form it can be forged to any shape.

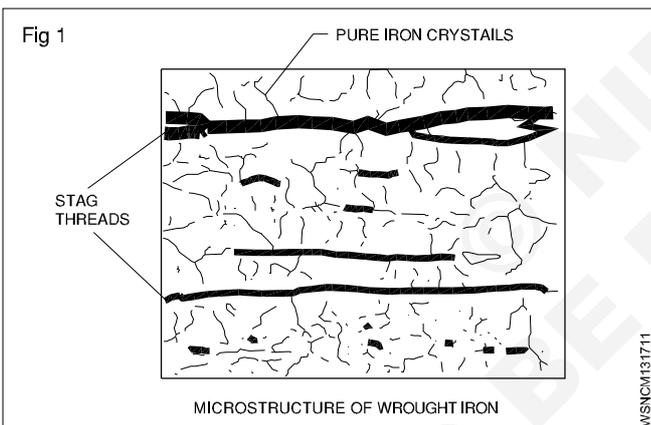

Modern methods used to produce wrought iron in large quantities are the

- puddling process
- aston or Byers process

Steel

This is pure iron. Carbon content is more. Due to excessive carbon it is harder and tougher. Carbon content is from 0.15 to 1.5%. Besides there are other impurities like sulphur, phosphorous etc. are there which cannot be separated. This is hardened and tempered by heating it to a definite temperature and cooling it in oil or water.

The following methods are adopted for making different types of steel:

- 1 Cementation process
- 2 Crucible process
- 3 Bessemer process
- 4 Open hearth process
- 5 Electro thermo process
- 6 High frequency process.

Types of steel

Main two types of steel are:

- 1 Plain steel
- 2 Alloy steel

1 Plain steel. In this carbon and iron are mixed. According to the percentage of carbon plain steels are classified as:

- A Low carbon steel
- B Medium carbon steel
- C High carbon steel

A Low carbon steel: It is also called mild steel. In this, the percentage of carbon is from 0.15% to 0.25%. Due to less quantity of carbon is sufficiently soft and tolerates the strain. It can be put in different shapes through forging and rolling. This is not very hard or strong. This cannot be hardened or tempered by ordinary methods. Nuts, bolts, rivets, sheets, wires, T-iron and angle iron etc. are made out of it.

B Medium carbon steel: The carbon content is from 0.25% to 0.5%. Due to excess of carbon, it is harder and tougher than mild steel. The tenacity is more. This can be hardened or tempered. Various things are made by forging and rolling. This is used for making high tensile tubes, wires, agricultural implements, connecting rods, cam shafts, spanners, pulleys etc.

C High carbon steel: It has carbon content from 0.5% to 1.5%. It is very hard and wears least. This can be hardened by heat treatment. This can neither be cast nor rolled. This is very hard and tough. It acquires permanent magnetic properties. This is used for making pointed tools, springs, pumps, files, cutleries, cold chisels press die etc.

2 Alloy Steel

When the steel is mixed with other metals like vanadium, manganese tungsten etc., it is called an alloy steel. Alloy steel has properties of its ingredients.

Types of Alloy Steel

Two types of alloy steel are:

- A Low alloy steel
- B High alloy steel

A Low Alloy steel: Besides carbon other metals are in lesser quantity. Its tensile strength is more. The welding can work on it. This can also be hardened and tempered. It is used in manufacturing various parts of an aeroplane and cam shaft etc.

B High Alloy Steel: Besides carbon it has a high percentage of the metals higher than low steel alloy. This is classified into following types:

a High Speed Steel: It is also called high tungsten alloy steel because it has more quantity of tungsten. According to the quantity of tungsten it is classified into three types:

- 1 Tungsten 22%, Chromium 4%, Vanadium 1%
- 2 Tungsten 18%, Chromium 4%, Vanadium 1%
- 3 Tungsten 14%, Chromium 4%, Vanadium 1%

Cutting tools are made out of it because it is very hard but becomes soft at low critical temperature. This temperature is raised out of cutting process of tool, then the cutting tool becomes useless and is unfit for work. But due to high percentage of tungsten it keeps working upto high temperature. It is used for cutting tools, drills, cutters, reamers, hacksaw blades etc.

b Nickel Steel: In this 0.3% carbon and 0.25 to 0.35% nickel is present. Due to nickel its tensile strength, elastic limit and hardness is increased. It does not catch rust. Its cutting resistance increases 6 times more than plain carbon and steel due to 0.35% nickel present in it. This is used for making rivets, pipes, axle shafting, parts of buses and aeroplanes. If 5% of cobalt is mixed with 30-35% nickel, it becomes invar steel. It is mainly used for making precious instruments.

c Vanadium Steel: It contains 1.5% carbon 12.5% tungsten, 4.5% chromium, 5% vanadium and 5% cobalt. Its elastic limit, tensile strength and ductility is more. It has strength to bear sharp jerks. It is mainly used to manufacture of tools.

d Manganese Steel: It is also called special high alloy steel. It contains 1.6 to 1.9% of manganese

and 0.4 to 0.5% carbon. It is hard and less wear. It is not affected by magnet. It is used in grinders and rail points etc.

e Stainless Steel: Along with iron it contains 0.2 to 0.6% carbon, 12 to 18% chromium, 8% nickel and 2% molybdenum. It is used for making knives, scissors, utensils, parts of aeroplane, wires, pipes and gears etc.

Properties of stainless steel:

- 1 Higher corrosion resistance
- 2 Higher cryogenic toughness
- 3 Higher work hardening rate
- 4 Higher hot strength
- 5 Higher ductility
- 6 Higher strength and hardness
- 7 More attractive appearance
- 8 Lower maintenance

f Silicon Steel: It contains 14% of silicon. Its uses are multifarious according to the percentage of silicon. 0.5% to 1% silicon, 0.7 to 0.95% manganese mixture is used for construction work. 2.5 to 4% silicon content mixture is used for manufacturing electric motors, generators, laminations of transformers. In chemical industries 14% silicon content mixture is used.

g Cobalt Steel: High carbon steel contains 5 to 35% cobalt. Toughness and tenacity is high. It has magnetic property therefore used to make permanent magnets.

Material science - Difference between iron & steel, alloy steel and carbon steel

Difference between iron and steel:

S.No	Basic distinction	Iron	Steel
1	Formation	Pure substance	Made up of iron and carbon
2	Types	Cast iron, Wrought iron and steel	Carbon steel and alloy steel
3	Rusting	Quickly gets oxidised and result in rust	Have different elements that protect from rusting
4	Surface	Its surface is rusty	Its surface stays shiny
5	Usage	Used in buildings, tools and automobiles	Used in buildings, cars, railways and automobiles
6	Existence	Available in nature	Has to be formed

Steel Plants in India

S.No	Name of the Steel plant	State
1	Tata Iron	Bihar
2	Indian Iron Steel	West Bengal
3	Vishweshvaraiyah Iron Steel	Karnataka
4	Bhilai Steel Plant	Chhattisgarh
5	Durgapur Steel Plant	West Bengal
6	Alloy Steel Plant (Durgapur)	West Bengal
7	Bokaro Steel Plant	Bihar
8	Rourkela Steel Plant	Orissa
9	Salem Steel Plant	Tamilnadu
10	Visakhapatnam Steel Plant	Andhra Pradesh

Comparison of the Properties of Cast Iron, Mild Steel and steel

Property	Cast Iron	Mild Steel	Steel
Composition	Carbon contents from 2 to 4.5%	Carbon contents from 0.1 to 0.25%	Carbon contents from 0.5 to 1.7%
Strength	- High compressive strength - Poor tensile strength - Poor shearing strength	- Moderate compressive strength - Moderate tensile strength - High shearing strength	- High compressive strength - High tensile strength - High shearing strength
Malleability	Poor	High	High
Ductility	Poor	High	High
Hardness	Moderately hard and can be hardened by heating to hardening temperature and quenching	Mild	Hard
Toughness	Possesses poor toughness	Very tough with carbon content	Toughness varies
Brittleness	Brittle	Malleable	Malleable
Forgeability	Cannot be forged	Can be forged	Can be forged
Weldability	Cannot be welded with difficulty	Can be welded very easily	Can be welded
Casting	Can be easily cast	Can be cast but not easily	Can be cast
Elasticity	Poor	High	High

Ferrous metals	Non Ferrous metals
1 Iron content is more	1 Iron content is missing
2 The melting point is high	2 The melting point is low.
3 This is of brown and black colour	3 This is of different colours
4 This catches rust	4 This doesn't catch rust.
5 This can be magnetised	5 This cannot be magnetised
6 This is brittle in cold state.	6 This becomes brittle in hot state.

Difference between cast Iron and steel

Cast Iron	Steel
1 Carbon content is high	Carbon content is less
2 Carbon is in free state	Carbon is mixed
3 Melting point is low	Melting point is high
4 It cannot be magnetised	It can be magnetised
5 Because it is brittle, it cannot be forged	It can be forged
6 It rusts with difficulty	It rusts quickly
7 It cannot be welded	It can be welded

Difference between metals and non-metals

Metals	Non Metals
Shiny	Dull
Usually good conductors of heat and electricity	Usually poor conductors of heat and electricity
Most are ductile	Not ductile
Opaque (opposite of 'transparent')	Transparent when as a thin sheet
Most are malleable	Usually brittle when solid
Form alkaline oxides	Form acidic oxides
Sonorous (make a bell-like sound when struck)	Not sonorous
Usually have 1-3 valence electrons	Usually have 4-8 valence electrons
Most corrode easily	
Usually high melting point (usually solid at room temperature except for mercury)	

Difference between Carbon steel and alloy steel

Carbon Steel	Alloy Steel
1 Melting point is low	Melting point is high
2 Easy to work	Hard to work
3 Uniform hardness is not obtained	Uniform hardness is achieved
4 Cutting tool blunt at high temperature during operation	Cutting tool does not blunt at high temperature during operation
5 Rust easily	Does not rust easily
6 Corrosion in acid	Does not corrosion in acid
7 Magnetically attracted	Not attractive by magnetism
8 Low cost	High cost

Material science - Properties and uses of insulating materials

Properties and uses of Insulating materials

Description

These are the materials which offer very high resistance to the flow of current and make current flow very negligible or nil. These materials have very high resistance - usually of many megohms (1 Megohm = 10^6 ohms) are centimetre cubed. The insulators should also possess high dielectric strength. This means that the insulating material should not break down or puncture even on application of a high voltage (or high electrical pressure) to a given thickness.

Properties of insulators

The main requirements of a good insulating material are:

- High specific resistance (many megohms/cm cube) to reduce the leakage currents to a negligible value.

- Good dielectric strength i.e. high value of breakdown voltage (expressed in kilovolts per mm).
- Good mechanical strength, in tension or compression (It must resist the stresses set up during erection and under working conditions.)
- Little deterioration with rise in temperature (The insulating properties should not change much with the rise in temperature i.e. when electrical machines are loaded.)
- Non-absorption of moisture, when exposed to damp atmospheric condition. (The insulating properties, specially specific resistance and dielectric strength decrease considerably with the absorption of even a slight amount of moisture.)

Products and insulators

Insulators	Uses in electric field
1 Mica	In elements or winding (Slot insulation)
2 Rubber	Insulation in wires
3 Dry cotton	Winding
4 Varnish	Winding
5 Asbestos	In the bottom of irons and kettles, etc.
6 Gutta parcha	Submarine cables
7 Porcelain	Overhead lines insulators
8 Glass	-do-
9 Wood dry	Cross arms in overhead lines
10 Plastic	Wires insulation or switches body
11 Ebonite	Bobbin of transformer
12 Fibre	Bobbin making and winding insulation
13 Empire cloth	Winding insulation
14 Leathroid paper	-do-
15 Millimax paper	-do-
16 P.V.C.	Wire insulation
17 Bakelite	Switch etc. making, for insulation
18 Shellac	-do-
19 Slate	Making panel board
20 Paraffin Wax	Sealing

Mass, Weight, Volume and Density - Mass, volume, density, weight and specific gravity

Mass

Mass of a body is the quantity of matter contained in a body. The unit of mass in F.P.S system is pound (lb), in C.G.S. system gram (gr) and in M.K.S and S.I systems kilogram (kg). 1 ton which is 1000 kg is also used sometimes. The conversion factor is 1000. Three decimal places are shifted during conversion. E.g. 1 ton = 1000 kg 1g = 1000mg.

m - mass of a body

g - acceleration due to gravity in metre/sec² = 9.81 m/sec²

V - volume of the body

ρ - density (pronounced as 'rho')

W or FG - weight or weight force

Mass (Fig 1)

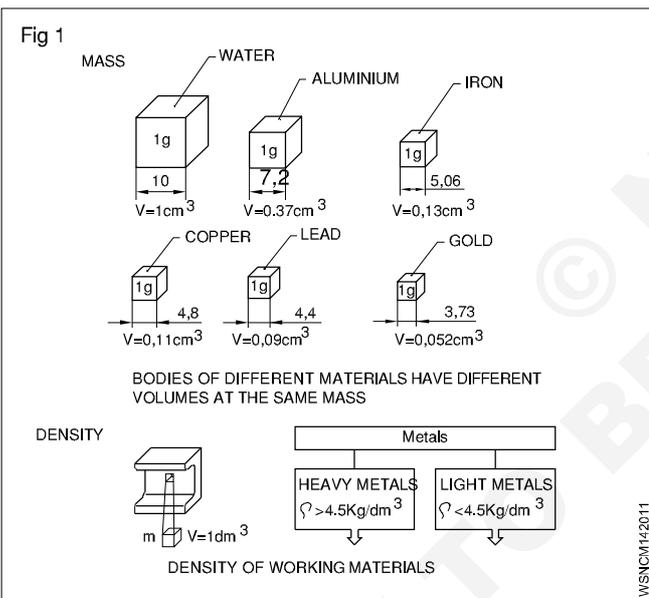

Density

Density is the mass of a body per unit volume. Hence its unit will be gr/cm³ or kg/dm³ or ton/m³.

$$\text{Density} = \frac{\text{mass}}{\text{volume}} = \frac{m}{v} = \rho$$

Weight (Fig 2)

Weight is the force with which a body is attracted by the earth towards its centre. It is the product of the mass of the body and the acceleration due to gravity. The weight of a body depends upon its location.

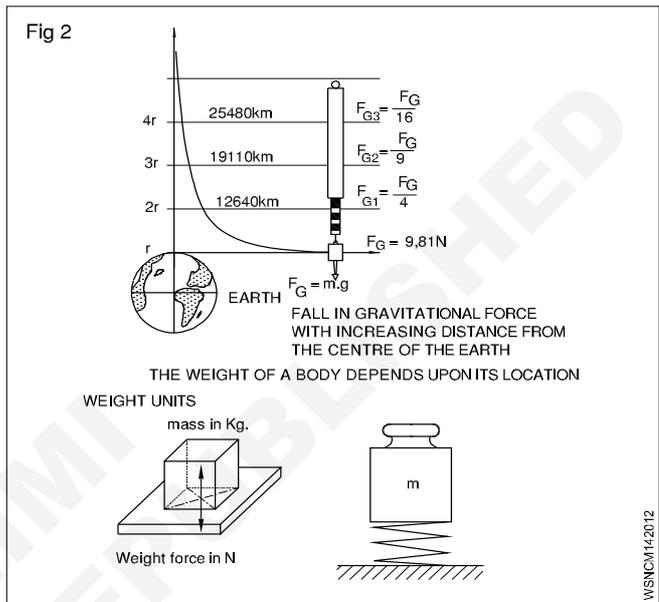

weight = W or FG = mass x gravitational force = m x g

System	Absolute unit	Derived unit	Conversion
F.P.S. system	1 poundal	1 Lb wt	32.2 poundals (1 lb x 1 ft/sec ² = 1 pound)
C.G.S. system	1 dyne 1 gr x 1 cm/sec ²	1 Gr.wt	981 dynes
M.K.S.	Newton	1 kg.wt	1 Newton =
S.I. system	Newton	Newton	1 kg x 1 m/sec ²

1 kg.wt = 9.81 Newton (approximately 10N) **1 Newton = 10⁵ dynes.**

Difference between mass and weight

S. No	Mass	Weight
1	Mass is the quantity of matter in a body (ie) measurement of matter in a body	Weight is measure of amount of force acting on mass due to acceleration due to gravity
2	It does not depend on the position or space	It depends on the position, location and space
3	Mass of an object will not be zero	Weight of an object will be zero if gravity is absent
4	It is measured using by physical balance	It is measured using by spring balance
5	It is a scalar quantity	It is a vector quantity
6	When immersed in water mass does not change	When immersed in water weight will change
7	The unit is in grams and kilogram	The unit is in kilogram weight, a unit of force

Mass and weight are different quantities.
Mass of a body is equal to volume x density.
Weight force is equal to mass x acceleration due to gravity.

Weight , Density and Specific gravity

It is now seen that the mass of a substance is measured by its weight only without any reference to volume. But if equal weights of lead & aluminium, are compared the volume of lead is much smaller than volume of aluminium. So we can now say that lead is more dense than aluminium, .i.e In other words the density of lead is greater than aluminium. (Fig 3 & 4)

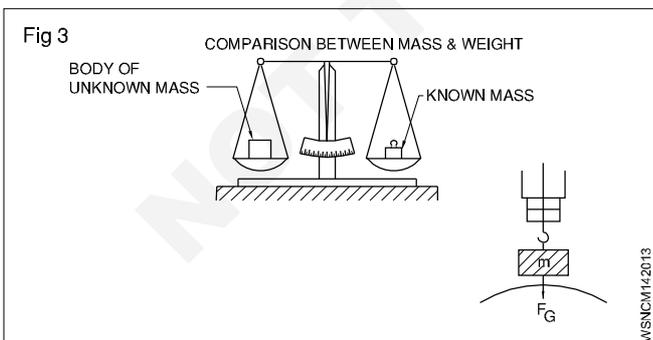

The relation of mass and volume is called density.

The density expresses the mass of volume E.g. 1 dm³ of water has the mass of 1kg - thus the density of 1kg/dm³ (Fig 2)

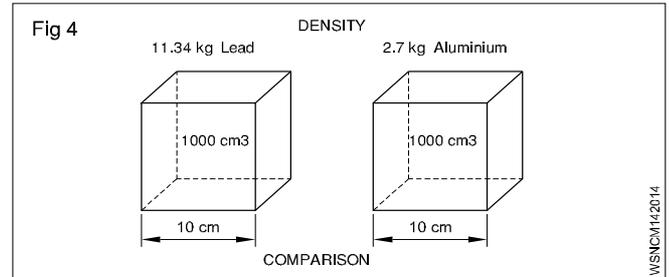

Unit

The density is measured as below

MKS/SI= Kg/m³, CGS = 1 gm/cm³ FPS = lbs/c ft

Solids	gm/cc	Liquids	gm/cc
1 Aluminium	2.7	Water	1.00
2 Lead	11.34	Petrol	0.71
3 Cast iron	6.8 to 7.8	Oxygen	1.43
4 Steel	7.75 to 8.05	Diesel Oil	0.83

The specific gravity of a substance is also called its relative density.

Formula

Specific gravity
 (or) Relative density = $\frac{\text{Density of the substance}}{\text{Density of the water at } 4^{\circ}\text{C}}$

= $\frac{\text{Mass of any volume of a substance}}{\text{Mass of an equal volume of water at } 4^{\circ}\text{C}}$

Comparison Between Density And Specific Gravity (Relative Density)

Density	Relative density or Specific gravity
Mass per unit volume of a substance is called its density Its unit is gm per cu cm; lbs per cu.ft and kg/cubic meter	The density of substance to density of water at 4°C is its relative density It has no unit of measurement simply expressed in a number
Density = $\frac{\text{Mass}}{\text{Volume}}$	Relative density = $\frac{\text{Density of the substance}}{\text{Density of water at } 4^{\circ}\text{C}}$

Solids	Sp.gy	Liquids	Sp.gy
1 Aluminium	2.72	Petrol	0.71
2 Lead	11.34	Battery acid	1.2 to 1.23
3 Cast iron	6.8 to 7.8	Water	1.00
4 Steel	7.82	Diesel Oil	0.83

From the above table, we can calculate the weight of any given volume of a substance (say Diesel oil) in any units provided we know the specific gravity of the substance. Also vice-versa for volume of density is known.

Mass, Weight, Volume and Density - Related problems for mass, volume, density, weight and specific gravity

- 1 Calculate the mass in kg of a rectangular steel plate of dimensions 220 x 330 x 15 mm (Fig 1) (density of steel = 7.82 gm/cm³)

$$\begin{aligned} \text{Mass} &= \text{Volume} \times \text{density} \\ &= 22 \times 33 \times 1.5 \text{cm} \times 7.82 \text{ gm/cm}^3 \\ &= 1089 \text{ cm}^3 \times 7.82 \text{ gm/cm}^3 \\ \text{mass} &= 8.516 \text{ kg} \end{aligned}$$

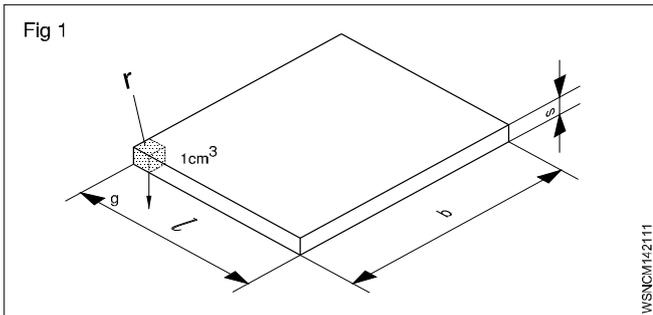

- 2 What is the weight in Newton if a storage container holds 250 litres of water and amount of water exert on the surface which it is standing? (Fig 2)

(1 litre of water = 1 kg of water)
 Density of water 1 gm/cm³ or 1 kg/dm³

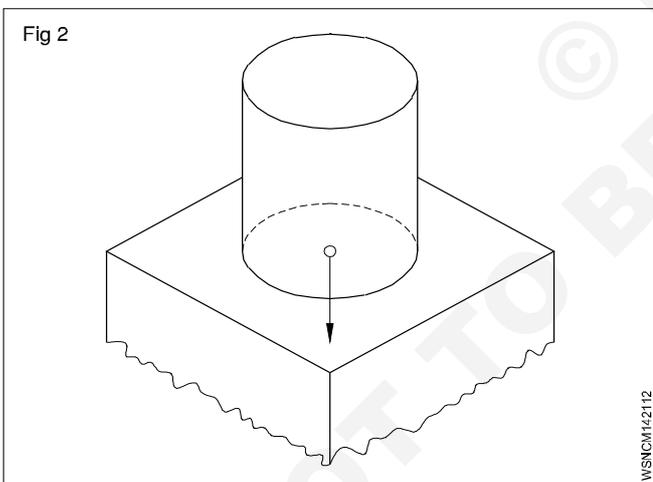

Acceleration due to gravity is taken as 10 metre/sec² (approximation).

$$\begin{aligned} \text{Capacity} &= 250 \text{ litres} = 250 \text{ dm}^3 \text{ in volume.} \\ \text{Mass of water} &= \text{volume} \times \text{density of water} \\ &= 250 \text{ dm}^3 \times 1 \text{ kg/dm}^3 = 250 \text{ kg} \\ \text{Weight extended} &= \text{mass} \times \text{acceleration due to gravity} \\ &= 250 \text{ kg} \times 10 \text{ metre/sec}^2 \\ &= 2500 \text{ kg.metre/sec}^2 = 2500 \text{ N} (\because 1 \text{ kg.m/sec}^2 = 1\text{N}) \end{aligned}$$

- 3 A force of 15 dynes acting on a mass of 'm' produces an acceleration of 2.5 cm/sec². Find the mass.

$$1 \text{ Gr. wt.} = 981 \text{ dynes}$$

$$\therefore 15 \text{ dynes} = \frac{15}{981} \text{ Gr.wt}$$

$$\text{Force} = m \times \text{acceleration produced by the force}$$

$$\therefore \text{Gr.wt} = \text{mass} \times 2.5 \text{ cm/sec}^2$$

$$\therefore \text{gr.cm/sec}^2 = \text{mass} \times 2.5 \text{ cm/sec}^2$$

$$\therefore \text{mass} = \frac{15}{981 \times 2.5} \text{ grams} = \frac{\text{gm.cm/sec}^2}{\text{cm/sec}^2}$$

$$\text{mass} = 0.00612 \text{ gram}$$

- 4 A force of 2 N acts on a mass of 10 kg. Find the acceleration produced by the force on the mass.

$$\text{Force} = 2 \text{ N} (\because 1 \text{ N} = 1 \text{ kg.m/sec}^2)$$

$$\text{Force} = \text{mass} \times \text{acceleration}$$

$$\therefore 2 \text{ kg.metre/sec}^2 = 10 \text{ kg} \times \text{acceleration produced}$$

$$\therefore 2 \times 1 \text{ kg.metre/sec}^2 = 10 \text{ kg} \times \text{acceleration produced}$$

$$\therefore \text{acceleration produced} = \frac{2}{10} \text{ metre/sec}^2$$

$$= 0.2 \text{ metre/sec}^2$$

- 5 Calculate the weight of a body having a mass of 1 kg if the acceleration due to gravity is 9.81 metre/sec²

$$\begin{aligned} \text{Weight force} &= \text{mass} \times \text{acceleration due to gravity} \\ &= 1 \text{ kg} \times 9.81 \text{ metre/sec}^2 \end{aligned}$$

$$(1 \text{ kg.metre/sec}^2 = 1 \text{ N})$$

$$\therefore 9.81 \text{ kg metre/sec}^2 = 9.81 \text{ N}$$

In the examples solved the value of 'g' is taken as 10 metre/sec², unless specifically mentioned otherwise.

- The outside and inside diametres of a hollow sphere are 150 & 70mm respectively. Calculate its mass if the density of material is 7.5 gm/cm³. (Fig 3)

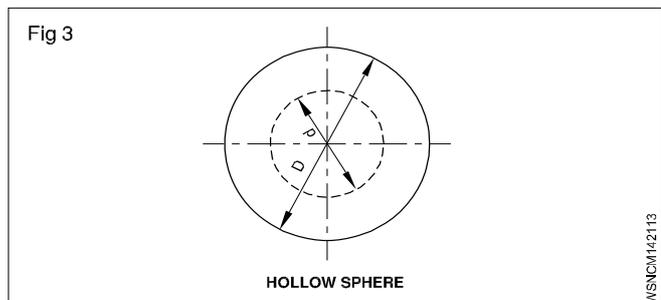

$$\text{Mass} = \text{Volume} \times \text{Density}$$

$$= \text{Volume} \times 7.5 \text{ gm/cm}^3$$

$$D = 150 \text{ mm} = 15 \text{ cm} \quad R = 7.5 \text{ cm}$$

$$d = 70\text{mm} = 7\text{ cm} \quad r = 3.5\text{ cm}$$

$$\text{Volume} = \frac{4}{3}\pi(R^3 - r^3)\text{unit}^3$$

$$= \frac{4}{3}\pi(7.5^3 - 3.5^3)$$

$$= 1587.5\text{ cm}^3$$

$$\text{Mass} = 1587.5\text{ cm}^3 \times 7.5\text{ gm/cm}^3$$

$$= 11906.6\text{ gm} = 11.9\text{ kg} \quad \text{say } 12\text{ kg}$$

6 A car has a mass of 800 kg. Find out its weight force (Take 9.81 m/sec^2)

$$(\because 1\text{ N} = 1\text{ kg}\cdot\text{m/sec}^2)$$

The Wt. force of a car = Mass of car x gravitational acceleration

$$= 800 \times 9.81\text{ N}$$

$$= 7848\text{ Newtons}$$

7 A cylindrical tank 2m dia x 3.5 m length is filled with petrol. Find the weight of petrol in Tonnes, Assume density of petrol 720 Kg/m^3 . (Fig 4)

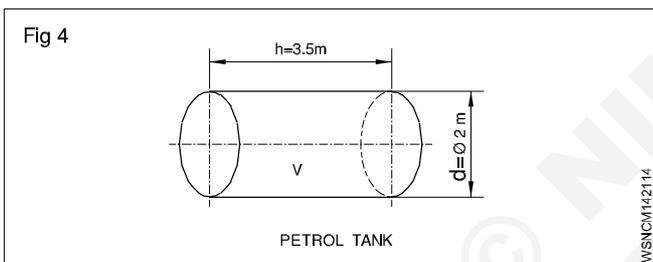

Volume of Tank

$$v = \pi r^2 l \text{ (or) } \frac{\pi d^2}{4} \times l \text{ unit}^3 = \frac{\pi \times 2^2}{4} \times 3.5\text{ m}^3$$

$$3.14 \times 3.5\text{ m}^3 = 10.99\text{ m}^3$$

$$\text{Since } 1\text{ m}^3 = 1000\text{ litres}$$

$$\text{Volume of Tank} = 10.99 \times 1000\text{ litres}$$

$$\text{Density of petrol} = 720\text{ Kg/m}^3$$

$$\text{Weight of Petrol in Kg} = 10.99 \times 1000\text{ litres} \times 720\text{ Kg}$$

$$= 720 \times 10990\text{ Kg}$$

Weight of Petrol in Tonnes

$$\text{(Metric Units)} = \frac{720 \times 10990}{1000}$$

$$\text{Weight of Petrol} = 7912.8\text{ Tonnes}$$

8 If the battery acid specific gravity is 1.3, and this is being filled up into a cylindrical tank. Find out its density.

$$\text{(Density of water} = 1\text{ gm/cm}^3)$$

Specific gravity or Relative density

$$= \frac{\text{Density of the substance}}{\text{Density of water at } 4^\circ\text{c}}$$

Now, density of battery acid

$$= \text{Specific gravity} \times \text{Density of water}$$

$$= 1.3 \times 1\text{ gm/cm}^3$$

$$= 1.3\text{ gm/cm}^3$$

Determination of specific gravity of a substance

The specific gravity of a substance may be determined by

1 Archimedes Principle

2 Hydrometer

Archimedes Principle

Archimedes principle states that when a body is fully or partially immersed in a liquid, the amount of liquid displaced by the body is equal to the loss of weight of the body in the liquid.

Weight of a body in a liquid = total weight of the body

- weight of the liquid displaced by the body

This quantity if it is zero then the body will float. It is negative the body will rise up till the weight of liquid displaced by the immersed portion of the body is equal and equal to the weight of the body. If it is positive the body will sink. Specific gravity of solids soluble in water

$$= \frac{\text{weight of solid in air}}{\text{loss of weight of solid in water}}$$

specific gravity of solids soluble in water

$$= \frac{\text{weight of solid in air} \times \text{specific gravity of the liquid}}{\text{loss of weight of solid in which the solid is in solution}}$$

specific gravity of a liquid

$$= \frac{\text{loss weight of a solid in water}}{\text{loss of weight of the same solid in liquid}}$$

The solid chosen should be such that it is insoluble in both water and the liquid whose specific gravity is to be determined.

Example

1 An iron piece weighs 160 kgf in air and 133 kgf when it is fully immersed in water. Determine the volume and specific gravity of the iron piece.

$$\text{Weight of the solid in air} = 160\text{ kgf}$$

$$\text{Weight of the solid in water} = 133\text{ kgf}$$

$$\therefore \text{Loss of weight in water} = 27\text{ kgf}$$

By Archimedes principle the loss of weight of a solid in water = volume of water displaced.

$$\therefore \text{Volume of water displaced} = 27\text{ cm}^3$$

$$\therefore \text{Volume of the solid} = 27\text{ cm}^3$$

$$\text{Density of the iron piece} = \frac{\text{mass of iron}}{\text{volume of the piece}}$$

$$= \frac{160}{160 - 133} = \frac{160}{27} = 5.93$$

$$\text{Specific gravity} = \frac{\text{density of iron}}{\text{density of water}} = \frac{5.93}{1} = 5.93$$

Specific gravity of iron piece = 5.93

- 2 A metal piece weighs 6.5 kgf in air and 3.5 kgf in water. Find its weight when it is fully immersed in a liquid whose specific gravity is 0.8 and also the S.G of the metal.

Weight of metal piece in air = 6.5 kgf

Weight of metal piece in water = 3.5 kgf

∴ Loss of weight in water = 3.00 kgf (6.5 - 3.5)

∴ Specific gravity of metal

$$= \frac{\text{Weight of substance in air}}{\text{Loss of weight in water}} = \frac{6.5\text{kgf}}{3\text{kgf}} = 2.166$$

By applying the principle of Archimedes the above results are derived.

The weight of the metal piece in the liquid = W

∴ loss of weight of the metal in the liquid = 6.5 kgf - W

$$\text{Specific gravity of the liquid} = \frac{\text{loss of weight in liquid}}{\text{loss of weight of water}}$$

$$\therefore 0.8 = \frac{6.5\text{kgf} - W}{3\text{kgf}}$$

$$\therefore W = 6.5 \text{ kgf} - 3 \text{ kgf} \times 0.8 = 4.1 \text{ kgf}$$

∴ loss of weight of the metal in the liquid = 4.1 kgf.

By using a hydrometer, the specific gravity of a liquid is determined. The most common type of hydrometer is the Nicholson's hydrometer which is a variable weight but constant immersion type.

Specific gravity of a liquid

wt. of hydrometer+ wt. required to sink the hydrometer in the liquid to a fixed mark

wt. of hydrometer+ wt. required to sink the hydrometer in water up to the same mark

- 3 A piece of wood having 80cc volume, when floated on water remains 60cc volume above water. Find the weight of the water displaced.

Water displaced = Immersed volume

Immersed volume = volume of wood - volume of wood above water level

$$= 80 - 60 = 20\text{cm}^3$$

Weight of water displaced = volume x density of water

$$= 20 \times 1 = 20 \text{ grams}$$

Sl.No	Substance	Density gm/cc
1	Aluminium	2.7
2	Cast Iron	6.8 - 7.8
3	Copper	8.92
4	Gold	19.32
5	Iron	7.86
6	Lead	11.34
7	Nickel	8.912
8	Silver	10.5
9	Steel	7.75 - 8.05
10	Tin	7.31
11	Zinc	7.14
12	Diamond	3.51
13	Bismuth	9.78
14	Brass	8.47
15	Phosphrous Bronze	8.7 - 8.9
16	Ice	0.93
17	Air	0.0013
18	Mercury	13.56
19	Petrol	0.71
20	Diesel	0.83
21	Kerosene	0.78 - 0.81
22	Water	1.0

Assignment

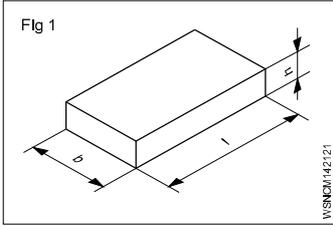
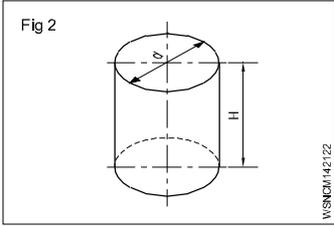
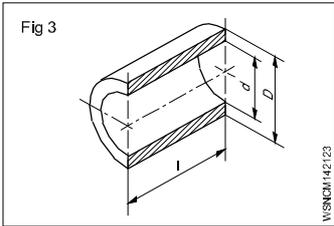
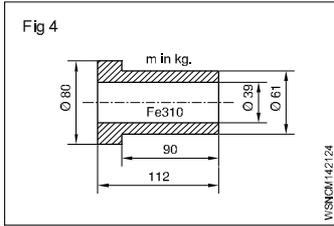
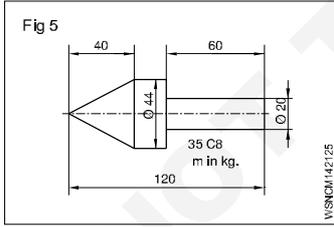
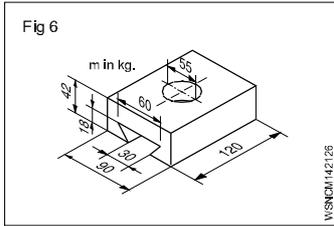
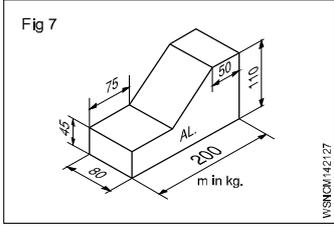
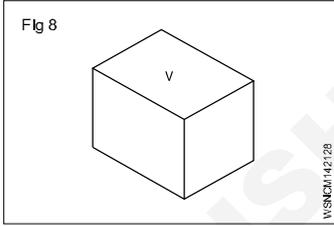
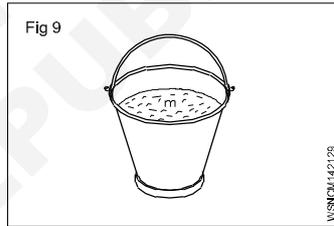
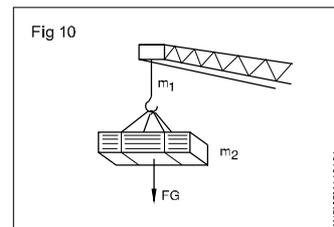
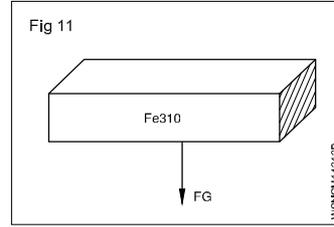
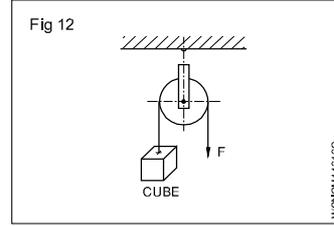
- 1  **Fig 1**
 $l = 1800 \text{ mm}$
 $b = 65 \text{ mm}$
 $h = 12 \text{ mm}$
 $\rho = 7.85 \text{ g/cm}^3$
 $m = \underline{\hspace{2cm}} \text{ kg}$
- 2  **Fig 2**
 Capacity = 36 litres
 $d = 32 \text{ cm}$
 $H = \underline{\hspace{2cm}} \text{ cm}$
- 3  **Fig 3**
 $D = 74 \text{ mm}$
 $d = 68 \text{ mm}$
 $l = 115 \text{ mm}$
 $\rho = 8.6 \text{ gm/cm}^3$
 $m = \underline{\hspace{2cm}} \text{ gms}$
- 4  **Fig 4**
 $D_1 = 80 \text{ mm}$
 $D_2 = 61 \text{ mm}$
 $d = 39 \text{ mm}$
 $L = 112 \text{ mm}$
 $l = 90 \text{ mm}$
 $\rho = 7.85 \text{ gm/cm}^3$
 $m = \underline{\hspace{2cm}} \text{ kg}$
- 5  **Fig 5**
 $D = 44 \text{ mm}$
 $d = 20 \text{ mm}$
 $L = 120 \text{ mm}$
 $l_1 = 60 \text{ mm}$
 $l_2 = 40 \text{ mm}$
 $\rho = 7.85 \text{ gm/cm}^3$
 $m = \underline{\hspace{2cm}} \text{ kg}$
- 6  **Fig 6**
 $L = 120 \text{ mm}$
 $B = 90 \text{ mm}$
 $b_1 = 60 \text{ mm}$
 $b_2 = 30 \text{ mm}$
 $d = 55 \text{ mm}$
 $H = 42 \text{ mm}$
 $h = 18 \text{ mm}$
 $\rho = 7.85 \text{ gm/cm}^3$
 $m = \underline{\hspace{2cm}} \text{ kg}$
- 7  **Fig 7**
 $L = 200 \text{ mm}$
 $l_1 = 75 \text{ mm}$
 $l_2 = 50 \text{ mm}$
 $B = 80 \text{ mm}$
 $H = 110 \text{ mm}$
 $h = 45 \text{ mm}$
 $\rho = 2.7 \text{ gm/cm}^3$
 $m = \underline{\hspace{2cm}} \text{ kg}$
- 8  **Fig 8**
 $V = 320 \text{ cm}^3$
 $\rho = 8.9 \text{ gm/cm}^3$
 $g = 9.80665 \text{ metre/sec}^2$
 $m = \underline{\hspace{2cm}} \text{ kg}$
 $FG = \underline{\hspace{2cm}} \text{ N}$
- 9  **Fig 9**
 Capacity = 35 litres
 $g = 10 \text{ metres/sec}^2$
 $FG = \underline{\hspace{2cm}} \text{ N}$
- 10  **Fig 10**
 (m_1) mass of chain = 150 kg
 Total FG = 8 kN
 Load = $\underline{\hspace{2cm}} \text{ N}$
 mass $m_2 = \underline{\hspace{2cm}} \text{ kg}$
- 11  **Fig 11**
 $W (FG) = 22.5 \text{ N}$
 $V (\text{volume}) = \underline{\hspace{2cm}}$
- 12  **Fig 12**
 $F = 250 \text{ d N}$
 side of cube = $\underline{\hspace{2cm}} \text{ mm}$
 (cubical counter weight balances 'F')

Speed and Velocity, Work, Power and Energy - Work, power, energy, HP, IHP, BHP and efficiency

Work (Fig 1)

Work is said to be done by a force, when it moves, its point of application through a distance. Applied force 'F' moves a body through a distance 's'.

Work done 'W' = F x s.

The S.I. unit of work is 1 joule which is the work done by a force of moving the body through a distance of 1 metre.

Therefore joule = 1 N x 1 metre = 1 Nm

Also 1 joule = 1 Nm = 10⁵ dynes x 100 cm = 10⁷ dynes cm = 10⁷ ergs.

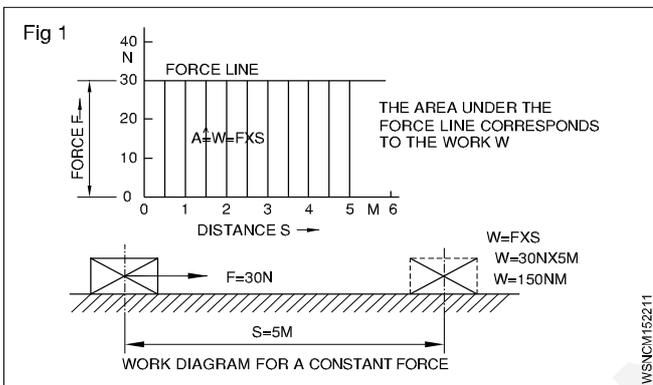

F - force or weight force in N

s - distance the body on which force acts is moved in metres

t - time in seconds

v - speed in metre/sec

w - work done by the force in joules

P - Power in Watts

P_{out} - Power output

P_{in} - Power input

Force

A Force is that which changes or tends to change the state of rest or motion of a body.

Force = Mass x Acceleration

$$F = Ma$$

Unit

$$F = M \times a$$

$$= \text{kg} \times \text{m}/\text{sec}^2$$

$$= 1 \text{ Newton (SI unit)}$$

(Newton: If 1 kg of mass accelerates at the rate of 1m/sec² then the force exerted on the mass is 1 newton)

$$\text{FPS} = 1 \text{ pound} \times 1 \text{ Feet}/\text{second}^2$$

$$= 1 \text{ pound}$$

$$\text{CGS} = 1 \text{ gm} \times 1\text{cm}/\text{second}^2$$

$$= \text{Dyne}$$

$$\text{MKS} = 1 \text{ kg} \times 1\text{m}/\text{second}^2$$

$$= \text{Newton.}$$

$$1 \text{ Newton} = 10^5 \text{ dynes}$$

$$1\text{kg wt} = 9.81\text{N}$$

$$1 \text{ pound} = 4.448\text{N,}$$

$$\text{Newton} = 0.225 \text{ pound.}$$

Absolute units

In C.G.S. system unit of work = 1 erg = 1 dyne x 1 cm

In F.P.S system unit of work = 1 Foot poundal = 1 poundal x 1 foot

In M.K.S. system unit of work = 1 joule = 1 Newton x 1 metre

Derived units

C.G.S. system 1 gm Wt x 1 cm = 981 ergs.

F.P.S. system 1 ft lb = 981 foot poundal

M.K.S. system 1 kgf metre = 981 joule.

Power (Fig 2)

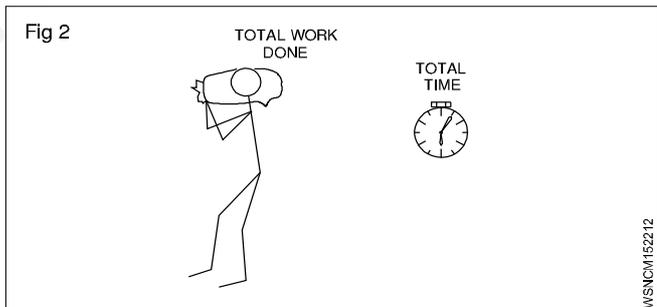

It is the work done in unit time.

$$\text{Power } P = \frac{\text{total work done}}{\text{total time}}$$

$$P = \frac{\text{Nm}}{\text{sec}}$$

$$\text{The S.I. units of power} = 1\text{Nm}/\text{sec} = \frac{1 \text{ joule}}{\text{sec}}$$

$$\text{which is} = 1 \text{ watt. power in watts} = \frac{w}{t} = \frac{F \cdot s}{t} = F \times V$$

which is equal to 1 Watt. Power in watts = w/t = F.s/t = F x V

In M.K.S. system the unit is 1 kgf meter/sec. One horse power is = 75 kg metre/sec or 4500 kgf metre/min.

1HP (metric) = 735.5 Watts

1HP (British) = 746 Watts = 0.746 KW

1 KW = 1.34 HP

Power input is the power given to a machine to do work. Power output is what we get out of the machine. Power output is always less than power input due to friction in the machine. The ratio between power output to power input is efficiency of the machine and it is expressed in percentage. (Fig 3)

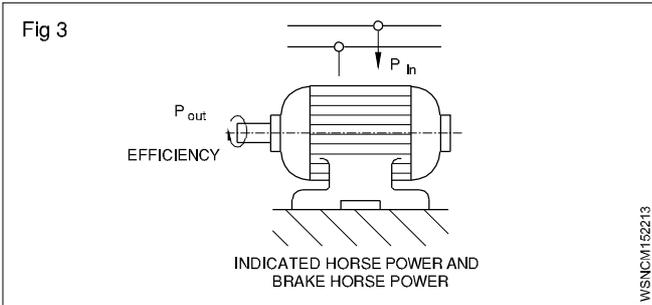

$$\text{efficiency} = \frac{\text{power output}}{\text{power input}} \times 100\%$$

Indicated Horse Power and Brake Horse Power

The power actually generated by the engine or generator is the indicated horse power which is indicated on the plate.

The Brake horse power is the power available to do useful work. B.H.P. is always less than I.H.P. due to losses to overcome frictional resistance.

$$\therefore \text{mechanical efficiency} = \frac{\text{B.H.P}}{\text{I.H.P}} \times 100\%$$

Work done by a force = Magnitude of the force x distance moved by the body

Power = Total work done / total time taken

$$\text{efficiency} = \frac{\text{power output}}{\text{power input}} \times 100\%$$

Energy

The energy of a body is its capacity to do work. It is equal to power x time. Hence the unit of energy is the same as the unit of work in all systems.

Forms of energy

Mechanical energy, Electrical energy, Atomic energy, Heat energy, Light energy, Chemical energy, sound energy. Energy of one form can be transformed into energy of another form.

Law of conservation of energy

- The energy can neither be created nor destroyed.
- Total energy possessed by a body remains the same. (Fig 4)

Depending upon the position of the body or body in motion, mechanical energy possessed by the body may be potential energy or kinetic energy respectively.

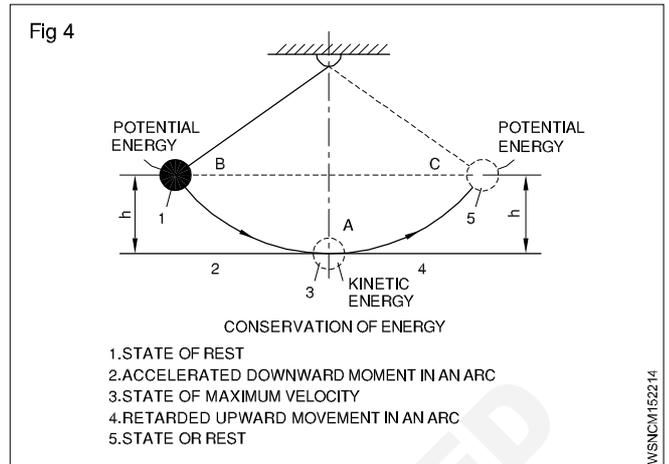

Examples

- 1 A man weighting 75kg climb 200 metre high hill. Find the Work done by a man?

Formula: Work done (W) = F x S

Given data: F = 75 kg
S = 200m

To find: Work done (W) = ?

Solution: Work done (W) = F x S
= 75 x 200 = 15000

Ans: Work done (w) = 15000 kgm

- 2 Find the work required to lift a mass of 36.3 Newtons through a height of 3.7 metres?

Formula: Work done (W) = F x S

Given data: F = 36.3 N
S = 3.7m

To find: Work done (W) = ?

Solution: Work done (W) = F x S
= 36.3 x 3.7 N.m
= 134.31 Joules

Ans: Work done (W) = 134.31 Joules

- 3 Calculate the Work done by a man weighing 50kg in carrying a mass of 20kg over his head when he covers a distance of 15metres in vertical direction.

Formula: Work done (W) = F x S

Given data: F = 50kg + 20kg = 70kg
S = 15 m

To find: Work done (W) = ?

Solution: Work done (W) = F x S
= 70 x 15 = 1050

Ans: Work done (W) = 1050 kg.m

- 4 A man weighing 60kg lifts a weight of 40kg to the top of building 12 metres height. Find the useful Work done by him and also the efficiency?

Formula: Work done (W) = F x S

Given data: Man weight = 60kg
Lifts a weight = 40kg
Total weight = 60 + 40 = 100kg
Distance (S) = 12 m

To find: a) Work done (W) = ?
b) Efficiency (η) = ?

Solution:

a) Work done (W) = F x S
= 100 x 12 = 1200 kg.m

b) Efficiency (η) = $\frac{\text{Output}}{\text{Input}} \times 100\%$
= $\frac{40 \times 12}{60 \times 12} \times 100\%$
= $\frac{480}{720} \times 100\%$
= 66.67%

Ans: a) Work done (W) = 1200 kg.m

b) Efficiency (η) = 66.67%

- 5 A pump pumps 4000kg of water from 50 metres depth in 40 minutes. Find the Work done by pump in one second?

Formula: Work done (W) = F x S

Given data: F = 4000 kg
S = 50 m

To find: Work done per second = ?

Solution:

Work done in 40 minutes,
Work done (W) = F x S
= 4000 x 50 = 200000 kgm
= $\frac{200000}{40} = 5000$

Work done in 1 second = $\frac{5000}{60} = 83.3$

Ans: Work done in 1 second (W) = 83.33 kg.m

- 6 A body of 225 kg is moved by 300 metres in 90 seconds. Find the power required to lift this body?

Formula: Power (P) = $\frac{F \times S}{t}$

Given data: F = 225 kg
S = 300m
t = 90 sec

To find: Power (P) = ?

Solution: Power (P) = $\frac{F \times S}{t}$
= $\frac{225 \times 300}{90}$ kg.m/sec
= 750 kg.m/sec

Ans: Power (P) = 750 kg.m/sec

- 7 A hydraulic press lifts a load of 5 tonnes in 5 minutes to a height of 5 metres. Calculate the power of the press?

Formula: Power (P) = $\frac{F \times S}{t}$

Given data: F = 5 tonnes = 5000 kg
S = 5 metres
t = 5 minutes = 5 x 60 = 300 sec

To find: Power (P) = ?

Solution: Power (P) = $\frac{F \times S}{t}$
= $\frac{5000 \times 5}{300} = 83.33$

Ans: Power (P) = 83.33 kg.m/sec

- 8 A machine weighing 750N takes 25N material to a height of 10 metres in one minute. calculate the power of machine?

Formula: Power (P) = $\frac{F \times S}{t}$

Given data:

Machine weight = 750N
Material weight = 25N
F = 750 + 25 = 775N
S = 10 m
t = 1 min = 60 sec

To find: Power (P) = ?

Solution: Power (P) = $\frac{F \times S}{t}$
= $\frac{775 \times 10}{60} = 129.17\text{N m/sec}$

Ans: Power (P) = 129.17N m/sec (or) watts

- 9 What is the power of pump which takes 15 seconds to lift 90kg of water to a tank situated at a height of 30 metres. (Take $g = 10\text{m/sec}^2$)?

Formula: Power (P) = $\frac{FxS}{t}$

Given data: F = 90 kg
S = 30 m
t = 15 sec

To find: Power (P) = ?

Solution: Power (P) = $\frac{FxS}{t}$

$$= \frac{f \times g \times s}{t}$$

$$= \frac{90 \times 10 \times 30}{15}$$

$$= 1800 \text{ Nm/sec} \quad \therefore (1 \text{ Nm/sec} = 1 \text{ watt})$$

Ans: Power (P) = 1800 watts

- 10 A hoist lifts a weight of 1000kg through a height of 33 metres in one minute. Find out the horsepower of the hoist?

Formula: Horsepower HP = $\frac{FxS}{t} \times \frac{1}{75}$

Given data: F = 1000 kg
S = 33 m
t = 1 minute = 60 sec

To find: Horsepower HP = ?

Solution: Horsepower HP = $\frac{FxS}{t} \times \frac{1}{75}$

($\therefore 75 \text{ kg.m/sec} = 1 \text{ HP}$)

$$= \frac{1000 \times 33}{60} \times \frac{1}{75}$$

$$= 7.33 \text{ H.P.}$$

Ans: Horsepower, HP = 7.33 H.P.

- 11 A pump can raise 900 litres of water per minute to a height of 45 metres. Calculate the H.P of pump?

Formula: Horsepower HP = $\frac{FxS}{t} \times \frac{1}{75}$

Given data: F = 900 litres = 900 kg
S = 45 m
t = 1 minute = 60 sec

To find: Horsepower HP = ?

Solution: Horsepower HP = $\frac{FxS}{t} \times \frac{1}{75}$

($\therefore 1 \text{ HP} = 75 \text{ kg.m/sec}$)

$$= \frac{900 \times 45}{60} \times \frac{1}{75} = 9 \text{ H.P}$$

Ans: Horsepower, HP = 9 H.P.

- 12 Find the horsepower of an engine to lift a weight of 2 tonnes to a height of 30 metres in two minutes?

Formula: Horsepower HP = $\frac{FxS}{t} \times \frac{1}{75}$

Given data: F = 2 tonnes = 2000 kg
S = 30 m
t = 2 minutes = 120 sec

To find: Horsepower HP = ?

Solution: Horsepower HP = $\frac{FxS}{t} \times \frac{1}{75}$

($\therefore 1 \text{ HP} = 75 \text{ kg.m/sec}$)

$$= \frac{2000 \times 30}{120} \times \frac{1}{75} = 6.67 \text{ H.P.}$$

Ans: Horsepower, HP = 6.67 H.P.

- 13 Find out horsepower of a pump required to lift 10000 litres of water in 3 minutes at height of 16 metres. Assume efficiency of pump as 94%?

Formula: Horsepower HP = $\frac{FxS}{t} \times \frac{1}{75}$

$$\eta = \frac{\text{Output}}{\text{Input}} \times 100\%$$

Given data: F = 10000 litres = 10000 kg
S = 16 metres
t = 3 minute = 180 sec

To find: Horsepower HP = ?

Solution: Horsepower HP = $\frac{FxS}{t} \times \frac{1}{75}$

($\therefore 1 \text{ HP} = 75 \text{ kg.m/sec}$)

$$= \frac{10000 \times 16}{180} \times \frac{1}{75}$$

$$= 11.85 \text{ H.P.}$$

$$\eta = \frac{\text{Output}}{\text{Input}} \times 100\%$$

$$94 = \frac{11.85}{\text{Input}} \times 100$$

$$\text{Input} = \frac{11.85 \times 100}{94} = \frac{1185}{94}$$

$$= 12.606 \text{ H.P.}$$

Ans: Input H.P of Pump = 12.606 H.P.

14 Find the horsepower of a motor which is required to lift 500 tonnes of coal per hour from a mine of 320 metre depth. Efficiency of motor is 0.75?

Formula: $\eta = \frac{\text{Output}}{\text{Input}} \times 100\%$

$$\text{Output H.P} = \frac{F \times S}{t} \times \frac{1}{75}$$

Given data:

F = 500 tonnes = 500000 kg

S = 320 metres

t = 1 hour = 3600 sec

$\eta = 0.75 = 75\%$

To find: Pump HP = ?

Solution:

$$\text{Output HP} = \frac{F \times S}{t} \times \frac{1}{75}$$

(\because 1 HP = 75 kg.m/sec)

$$= \frac{500000 \times 320}{3600} \times \frac{1}{75}$$

$$= 592.59 \text{ H.P.}$$

$$\eta = \frac{\text{Output}}{\text{Input}} \times 100\%$$

$$75 = \frac{592.59 \times 100}{\text{Input}}$$

$$\text{Input} = \frac{59259}{75}$$

Ans: Input = 790.12 H.P

15 A train weighing 25 tonnes is moving at a speed of 90km/hour. Find the horsepower of the engine, if the frictional force is 5kg per tonnes?

Formula: Horsepower HP = $\frac{F \times S}{t} \times \frac{1}{75}$

Given data: Train speed = 90 km/hour

$$= 90 \times \frac{1000}{3600} = 25 \text{ m/sec}$$

Train weight = 25 tonnes

Frictional force per tonnes = 5 kg

25 tonnes frictional force

(F) = 25 x 5 = 125kg

To find: Horsepower of the engine = ?

Solution: $\text{HP} = \frac{F \times S}{t} \times \frac{1}{75}$

$$= \frac{125 \times 25}{1} \times \frac{1}{75}$$

Ans: HP = 41.67 H.P.

16 A pump delivers 9000 litres of water per minute to a height of 14 metres. The efficiency of the pump is 78%. The efficiency of electric motor which drives the pump is 92%. Find out the input of the motor?

Formula: $\eta = \frac{\text{Output}}{\text{Input}} \times 100\%$

$$\text{Output H.P} = \frac{F \times S}{t} \times \frac{1}{75}$$

1 H.P = 0.7355 KW (metric)

Given data:

F = 9000 litres = 9000 kg

S = 14 metres

t = 1 minute = 60 sec

pump $\eta = 75\%$

motor $\eta = 92\%$

To find: Electric motor (KW) = ?

Solution:

$$\text{Pump Output HP} = \frac{F \times S}{t} \times \frac{1}{75}$$

$$= \frac{9000 \times 14}{60} \times \frac{1}{75}$$

$$= 28 \text{ H.P.}$$

Input of the pump

$$\eta = \frac{\text{Output}}{\text{Input}} \times 100\%$$

$$78 = \frac{28}{\text{Input}} \times 100$$

$$\text{Input} = \frac{28 \times 100}{78} = 35.9 \text{ H.P}$$

Output of the motor = Input of the pump

$$\text{Output} = 35.9 \text{ H.P}$$

Input of the motor

$$\text{Motor } \eta = \frac{\text{Output}}{\text{Input}} \times 100\%$$

$$92 = \frac{35.9}{\text{Input}} \times 100$$

$$\text{Input} = \frac{35.9 \times 100}{92} = 39.02 \text{ H.P}$$

Ans: Motor input = 39.02 H.P

17 I.H.P of generator is 6 H.P and its efficiency is 90%. Find tis B.H.P.

Formula: $\eta = \frac{\text{B.H.P}}{\text{I.H.P}} \times 100\%$

Given data:

I.H.P = 6 H.P
 $\eta = 90\%$

To find: B.H.P = ?

Solution: $\eta = \frac{\text{B.H.P}}{\text{I.H.P}} \times 100\%$

$90 = \frac{\text{B.H.P}}{6} \times 100\%$

$\frac{90 \times 6}{100} = \text{B.H.P}$

B.H.P = 5.4 H.P

Ans: B.H.P of generator = 5.4 H.P

18 A machine is working on 80% efficiency I.H.P of machine is 50. Calculate the power lost in friction.

Formula: I.H.P = B.H.P + Frictional losses

$\eta = \frac{\text{B.H.P}}{\text{I.H.P}} \times 100\%$

Given data: Efficiency $\eta = 80\%$

I.H.P = 50

To find: Friction = ?

Solution: $\eta = \frac{\text{B.H.P}}{\text{I.H.P}} \times 100\%$

$80 = \frac{\text{B.H.P}}{\text{I.H.P}} \times 100\%$

$80 = \frac{\text{B.H.P}}{50} \times 100\%$

$\frac{80 \times 50}{100} = \text{B.H.P}$

B.H.P = 40

B.H.P = I.H.P - F.H.P

40 = 50 - F.H.P

40 + F.H.P = 50

F.H.P = 50 - 40 = 10

Ans: Loss of friction = 10 H.P

Assignment

1

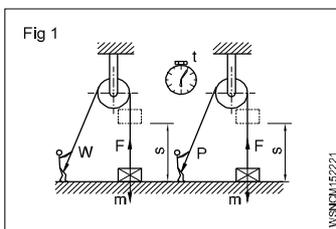

m = 55 kg

a) s = 1.82 metres
 W = _____ joules

b) s = 1.40 metres
 W = _____ joules

c) s = 0.85 metres

W = Joules

4

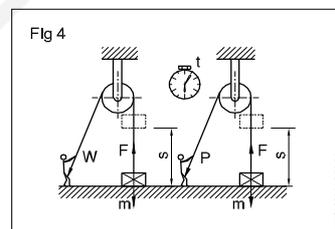

m = 75 kg

s = 100 metres

t = 12 secs

W = _____ N

P = _____ Watts

2

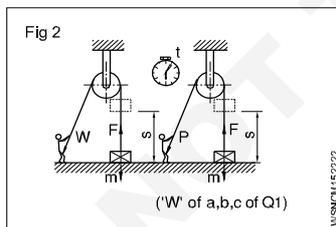

t = 8 secs

a) P = _____ Watts

b) P = _____ Watts

c) P = _____ Watts

(*W of a,b,c of Q1)

5

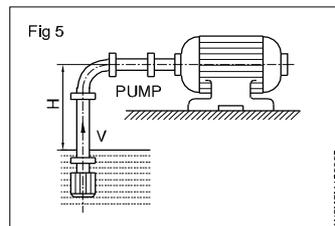

V = 1 m³/min

H = 2 m

$\eta = 0.75$

Power input = _____ kW

3

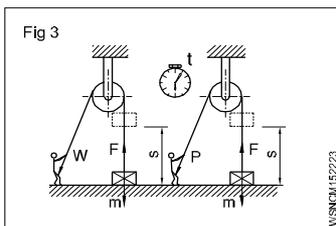

W = 1312.5 Joules

m = 350 kg

s = _____ metres

6

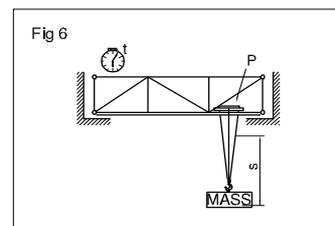

P = 12 kW

s = 4 metres

t = 20 secs

m = _____ kg

Heat & Temperature and Pressure - Concept of heat and temperature, effects of heat, difference between heat and temperature, boiling point & melting point of different metals and non-metals

Heat

It is a form of energy. Heat energy can be transformed into other forms of energies. Heat flows from a hotter body to a colder body. (Fig 1)

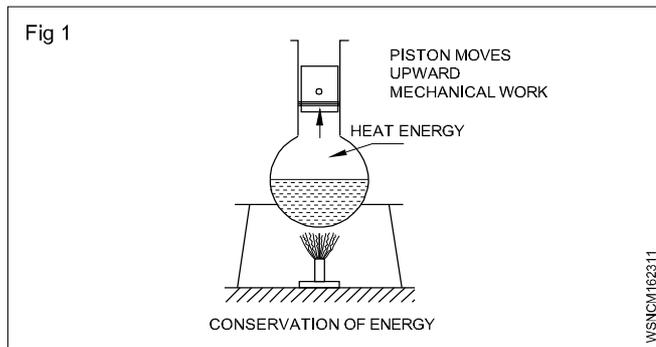

Units of heat

Calorie: It is the quantity of heat required to raise the temperature of 1 gram of water through 1°C.

BTHU: It is the quantity of heat required to raise 1 lb of water through 1°F. (British thermal unit).

C.H.U; It is the quantity of heat required to raise 1 lb of water through 1°C.

Joule : S.I. Unit (1 Calorie = 4.186 joule)

Effects of heat

- Change in temperature
- Change in size
- Change in state
- Change in structure
- Change in Physical properties

Specific heat

The quantity of heat required to raise the temperature of one gm of a substance through 1°C is called specific heat. It is denoted by the letter 's'.

Specific heat of water	= 1
Aluminium	= 0.22
Copper	= 0.1
Iron	= 0.12

Thermal capacity:

It is the amount of heat required to raise the temperature of a substance through 1°C is called the thermal capacity of the substance.

Thermal capacity = ms calories.

Calorific value: The amount of heat released by the complete combustion of unit quantity of the fuel (Mass or volume) is known as calorific value of fuels.

Water equivalent

It is the mass of water which will absorb the same amount of heat as the given substance for the same temperature rise. Water equivalent = Mass of the substance x specific heat of the substance.

Therefore water equivalent = ms

Types of heat

- 1 Sensible heat
- 2 Latent heat

1 Sensible heat

Sensible heat is the heat absorbed or given off by a substance without changing its physical state. It is sensible and can be absorbed by the variation of temperature in the thermometers.

2 Latent heat

The heat gained or given by the substance during a change of state (from solid to liquid to gas) is called latent heat or hidden heat. The heat absorbed or given off does not cause any temperature change in the substance.

- Types, 1. Latent heat of fusion of solid
2. Latent heat of vaporisation of solid.

1 Latent heat of fusion of solid

The amount of heat required per unit mass of a substance at melting point to convert it from the solid to the liquid state is called latent heat of fusion of solid. Its unit is cal/gram.

Latent heat of fusion of ice

The amount of heat required to convert per unit mass of the ice into water at 0°C temperature is called latent heat of fusion of ice.

Latent heat of fusion of ice(L) = 80 cal/gram

2 Latent heat of vaporisation of liquid

The amount of heat required to vaporise a unit mass of liquid at its boiling point is called latent heat of vaporisation.

Latent heat of vaporisation of water or latent heat of steam

The amount of heat required to convert into steam of a unit mass of water at its boiling point (100°C) is called latent heat of vaporisation of water or latent heat of steam.

Latent heat of steam(L) = 540 cal/gram

Temperature

It is the degree of hotness or coldness of a body. The temperature is measured by thermometers.

Difference between heat and temperature

Heat	Temperature
1 It is a form of energy.	This tells the state of heat.
2 Its unit is calorie.	Its unit is degree.
3 Heat is measured by calorimeter.	Temperature is measured by thermometer.
4 By adding quantity of heat of two substances their total heat can be calculated.	By adding two temperatures we cannot find the temperature of the mixture.
5 By heating a substance the quantity of heat is increased regardless of increase in temperature.	Two substances may read the same temperature though they might be having different amount of heat in them.

Boiling point

Any substance starts turning into a gas shows the temperature at which it boils this is known as the boiling point. The boiling point of water is 100°C.

Melting point

The temperature at which any solid melts into liquid or liquid freezing to solid is called the melting point of substance. The melting point of ice is 0°C.

List of melting point and boiling point of metals and Non -metals

Metals and Non-metals	Melting point °C	Boiling point °C	Metals and Non-metals	Melting point °C	Boiling point °C
Aluminium	660.25	2519	Manganese	1246	2061
Argon	-189.19	-185.85	Mercury	-38.72	357
Arsenic	817	614	Molybdenum	2617	4639
Barium	729	1897	Nickel	1453	2913
Beryllium	1287	2469	Nitrogen	-209.86	-195.79
Bromine	-7.1	58.8	Oxygen	-226.65	-182.95
Cadmium	321.18	767	Phosphorus (white)	44.1	280
Calcium	839	1484	Plutonium	640	3228
Carbon (diamond)	3550	4827	Potassium	63.35	759
Carbon (graphite)	3675	4027	Radium	700	1737
Chlorine	-100.84	-34.04	Silicon	1410	3265
Cobalt	1495	2927	Silver	961	2162
Copper	1084.6	2562	Sodium	98	883
Gold	1064.58	2856	Sulfur	115.36	444.6
Helium	-	-268.93	Tin	232.06	2602
Hydrogen	-259.98	-252.87	Titanium	1660	3287
Iodine	113.5	184.3	Tungsten (wolfram)	3422	5555
Iridium	2443	4428	Uranium	1132	4131
Iron	1535	2861	Zinc	419.73	907
Lead	327.6	1749			
Lithium	180.7	1342			
Magnesium	650	1090			

Heat & Temperature and Pressure - Scales of temperature, celsius, fahrenheit, kelvin and conversion between scales of temperature

Temperature Scales

Temperature is calibrated between two fixed reference points namely the freezing point of water, and the boiling point of water. These two fixed points on different temperature scales are:

Scale	Freezing point	Boiling point
Centigrade (°C)	0°C	100°C
Fahrenheit (°F)	32°F	212°F
Kelvin (K)	273°K	373°K
Reaumur (°R)	0°R	80°R

Heat is a form of energy. Temperature is the degree of hotness or coldness of a body. The relationship for conversion from one temperature scale to the others is

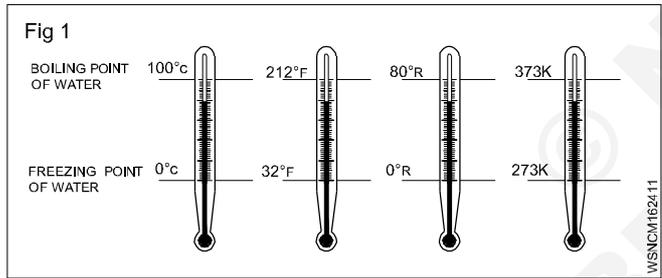
$$\frac{^{\circ}\text{R}}{80} = \frac{^{\circ}\text{C}}{100} = \frac{^{\circ}\text{K} - 273}{100} = \frac{^{\circ}\text{F} - 32}{180}$$

1 Convert 0°C into °F

$$\frac{^{\circ}\text{F} - 32}{180} = \frac{^{\circ}\text{C}}{100}$$

$$^{\circ}\text{F} - 32 = \frac{^{\circ}\text{C}}{100} \times 180$$

$$^{\circ}\text{F} - 32 = \frac{0}{100} \times 180$$

$$^{\circ}\text{F} = 0 + 32$$

$$= 32^{\circ}\text{F}$$

$$\mathbf{0^{\circ}\text{C} = 32^{\circ}\text{F}}$$

2 Convert -40°C into °F

$$\frac{^{\circ}\text{F} - 32}{180} = \frac{^{\circ}\text{C}}{100}$$

$$^{\circ}\text{F} - 32 = \frac{^{\circ}\text{C}}{100} \times 180$$

$$^{\circ}\text{F} - 32 = \frac{-40}{100} \times 180$$

$$\text{F} - 32 = -72$$

$$^{\circ}\text{F} = -72 + 32$$

$$= -40^{\circ}\text{F}$$

$$\mathbf{-40^{\circ}\text{C} = -40^{\circ}\text{F}}$$

3 Convert 37°C into K

$$\frac{^{\circ}\text{C}}{100} = \frac{^{\circ}\text{K} - 273}{100}$$

$$^{\circ}\text{K} - 273 = \text{C}$$

$$^{\circ}\text{K} = \text{C} + 273$$

$$^{\circ}\text{K} = 37 + 273$$

$$= 310 \text{ K}$$

$$\mathbf{37^{\circ}\text{C} = 310\text{K}}$$

4 Convert 70°C into Reaumur

$$\frac{^{\circ}\text{C}}{100} = \frac{^{\circ}\text{R}}{80}$$

$$^{\circ}\text{R} = \frac{\text{C}}{100} \times 80$$

$$^{\circ}\text{R} = \frac{70}{100} \times 80 = 56$$

$$\mathbf{70^{\circ}\text{C} = 56^{\circ}\text{R}}$$

5 Convert -25°F into °C

$$\frac{^{\circ}\text{C}}{100} = \frac{^{\circ}\text{F} - 32}{180}$$

$$\frac{^{\circ}\text{C}}{100} = \frac{-25 - 32}{180}$$

$$^{\circ}\text{C} = \frac{-57}{180} \times 100$$

$$^{\circ}\text{C} = \frac{-285}{9} = -31.66$$

$$\mathbf{-25^{\circ}\text{F} = -31.7^{\circ}\text{C}}$$

6 Convert 98.6°F into °C

$$^{\circ}\text{C} = \frac{^{\circ}\text{F} - 32}{180} \times 100$$

$$^{\circ}\text{C} = \frac{98.6 - 32}{180} \times 100$$

$$= \frac{66.6}{180} \times 100$$

$$= \frac{6660}{180} = 37^{\circ}\text{C}$$

$$\mathbf{98.6^{\circ}\text{F} = 37^{\circ}\text{C}}$$

Assignment

Convert the following

1 $10.5^{\circ}\text{C} = \underline{\hspace{1cm}}^{\circ}\text{F}$

2 $40^{\circ}\text{C} = \underline{\hspace{1cm}}^{\circ}\text{F}$

3 $60^{\circ}\text{C} = \underline{\hspace{1cm}}^{\circ}\text{F}$

4 $80^{\circ}\text{C} = \underline{\hspace{1cm}}^{\circ}\text{F}$

5 $105^{\circ}\text{C} = \underline{\hspace{1cm}}^{\circ}\text{F}$

6 $100^{\circ}\text{C} = \underline{\hspace{1cm}}^{\circ}\text{F}$

7 $-80^{\circ}\text{C} = \underline{\hspace{1cm}}^{\circ}\text{F}$

8 $200^{\circ}\text{C} = \underline{\hspace{1cm}}^{\circ}\text{F}$

9 $605^{\circ}\text{C} = \underline{\hspace{1cm}}^{\circ}\text{F}$

10 $1250^{\circ}\text{C} = \underline{\hspace{1cm}}^{\circ}\text{F}$

11 $77^{\circ}\text{F} = \underline{\hspace{1cm}}^{\circ}\text{C}$

12 $20^{\circ}\text{F} = \underline{\hspace{1cm}}^{\circ}\text{C}$

13 $428^{\circ}\text{F} = \underline{\hspace{1cm}}^{\circ}\text{C}$

14 $-210^{\circ}\text{F} = \underline{\hspace{1cm}}^{\circ}\text{C}$

15 $88^{\circ}\text{F} = \underline{\hspace{1cm}}^{\circ}\text{C}$

16 $110^{\circ}\text{F} = \underline{\hspace{1cm}}^{\circ}\text{C}$

17 $72^{\circ}\text{F} = \underline{\hspace{1cm}}^{\circ}\text{C}$

18 $50^{\circ}\text{F} = \underline{\hspace{1cm}}^{\circ}\text{C}$

19 $900^{\circ}\text{F} = \underline{\hspace{1cm}}^{\circ}\text{C}$

20 $72^{\circ}\text{R} = \underline{\hspace{1cm}}^{\circ}\text{C}$

21 $143^{\circ}\text{C} = \underline{\hspace{1cm}}\text{K}$

22 $373^{\circ}\text{K} = \underline{\hspace{1cm}}^{\circ}\text{C}$

23 $746^{\circ}\text{K} = \underline{\hspace{1cm}}^{\circ}\text{F}$

24 At what temperature will the reading of a fahrenheit thermometer be double of a centigrade one.

Heat & Temperature and Pressure - Temperature measuring instruments, types of thermometer, pyrometer and transmission of heat - Conduction, convection and radiation

Measuring heat energy

Energy can be released in chemical reactions as light, sound or electrical energy. But it is most often released as heat energy. This allows us to easily measure the amount of heat energy transferred.

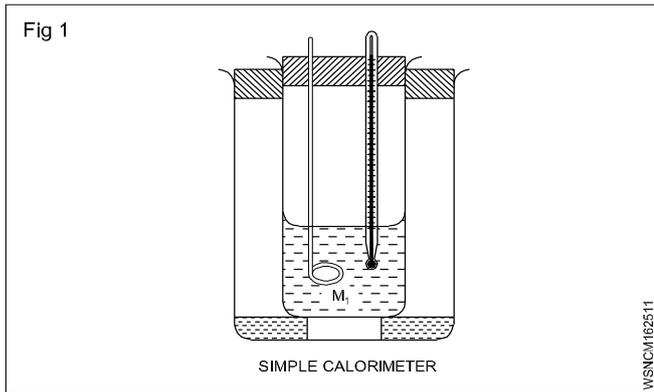

The apparatus used to measure the amount of heat by mixer method is called calorimeter. It is nothing but cylindrical shaped vessel and a stirrer made out of mostly copper.

In a calorimeter when the hotter solid/liquid substance are mixed with the cooler solid/liquid substances, heat transfer takes place until both substances reach the same temperature. By the same time calorimeter also reaches the same temperature. By mixing rule,

$$\text{Loss of heat by solid/liquid} = \left[\begin{array}{l} \text{Heat absorbed by} \\ \text{solid / liquid} \\ \text{substance} \end{array} \right] + \left[\begin{array}{l} \text{Heat absorbed} \\ \text{by calorimeter} \end{array} \right]$$

Measurement

Temperature is generally measured in degrees Celsius. In this system the freezing point of water is defined as 0°C and the boiling point of water is defined as 100°C. The Kelvin temperature scale begins from absolute 0. i.e. 273°. The temperature intervals are the same.

$$\therefore 273K = 0^\circ C, 20^\circ C = 273K + 20^\circ C = 293K.$$

Instruments

The instruments used to measure and read temperature takes into account changes in the properties of materials, electrical phenomena incandescence, radiation and melting.

Thermometer

Types of thermometer

- Forehead strips
- Wearable thermometers
- Pacifier thermometers

- Ear thermometers (tympanic)
- Forehead thermometers (temporal)
- Digital thermometers
- Mom's hand or lips

They are based on the principle that liquids and solids expand when they are subjected to heat. Mercury and alcohol expand uniformly. When heat is applied the volume of the liquid increases and the liquid rises in the capillary tube integral with the container. Mostly mercury is used in this type of thermometers because of its properties (Shiny and will not adhere to the glass tubes and we can measure up to 300°C.

The bimetal thermometer consists of metals with different coefficient of expansion. The bimetal is twisted into a spiral which curls when the temperature rises.

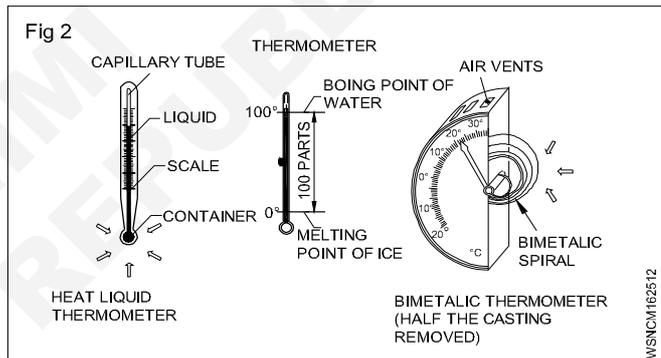

Pyrometer

Thermoelectric pyrometer is based on the principle that the soldering point between the wires of different metals, when heated a contact voltage is generated. The voltage depends upon the temperature difference between the hot measuring point and the cold end of the wire. Thermocouple elements are constructed of copper and Constant (up to 600°C) or of platinum and platinum-rhodium (up to 1600°C)

Radiation pyrometers are used to measure temperatures of red hot metals up to 3000°C. These concentrate thermal rays through an optical lens and focus them on to a thermo element. The scale of the ammeter is calibrated in degrees Celsius or Kelvin.

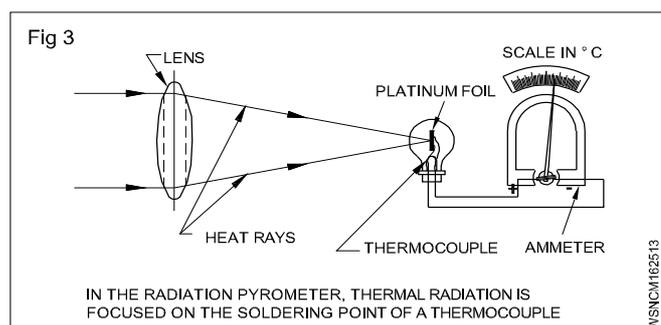

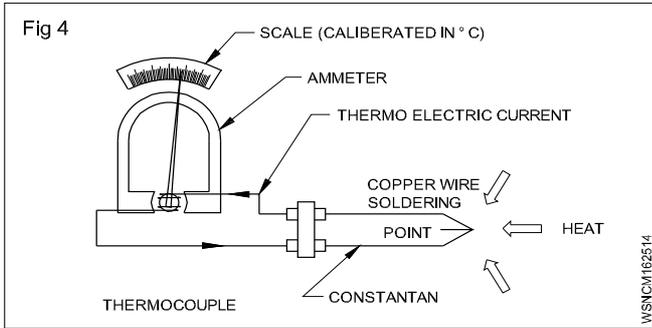

Transmission of Heat

Heat is a form of energy and is capable of doing work. Heat flows from a hot body to a colder body or from a point of high temperature to a point of low temperature. The greater is the temperature difference the more rapidly will be the heat flow. Heat is transmitted in three ways.

- 1 Conduction
- 2 Convection
- 3 Radiation

Conduction

Conduction is the name given to the transmission of heat energy by contact. The heat source is in contact with the Conductor. (metal rod). The rod is in contact with a thermometer. Due to Conduction heat is transferred from the heated end to the free end. In general good electrical conductors are also good heat conductors and good electrical insulators are also good heat insulators. A good heat insulator does not necessarily withstand high temperature.

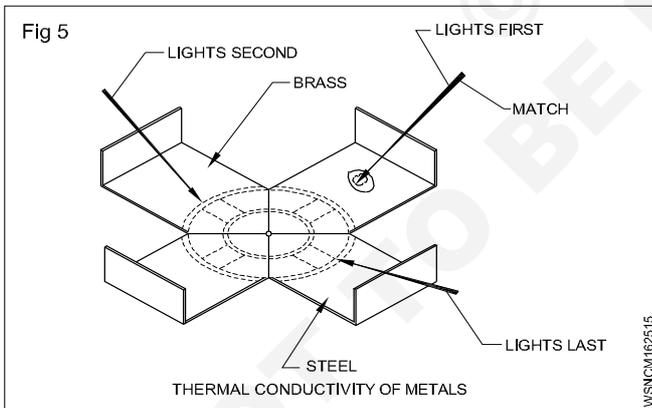

Convection

Convection is the name given to the transmission of heat energy by the up-ward flow. When heated, the fluid (liquid/gas) becomes less dense and because of its mobility, is displaced upwards, by a similar but colder and more dense fluid. e.g., The domestic hot water system, The cooling system in motor cars.

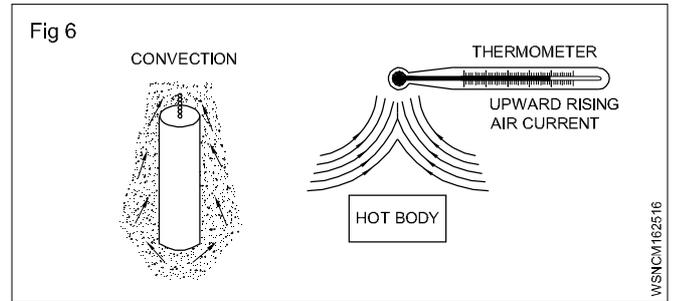

Radiation

Heat is radiated or transmitted from one object to the other in space without actually being in contact, by means of electro-magnetic waves. These waves are similar to light waves and radio waves. They can be refracted by lenses and reflected by mirrors. This radiation is called infrared. It requires no medium to carry the radiation. (e.g) The heat of the sun travels through the space.

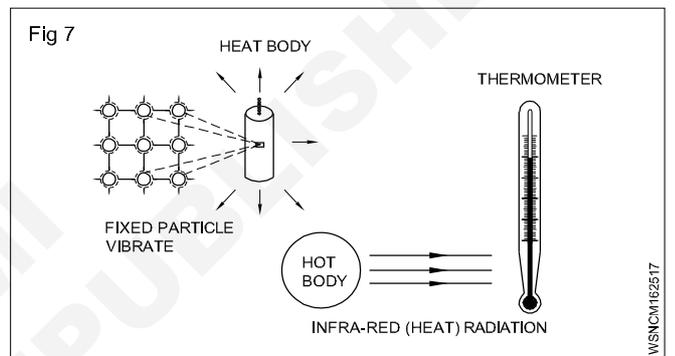

**Transmission of heat takes place in three ways
Conduction, Convection and Radiation.**

Expansion due to heat

When a solid, liquid or gaseous substance is heated, it expands and volume is increased. Similarly when it is cooled, it contracts (shrinks) and volume is decreased.

E.g : small gaps are left in between the lines of railway track to allow for expansion during summer. If this is not done, the rails would expand and bend there by causing derailment of trains.

Except a few substances, all solids, liquids and gases expand. For the same amount of heat given, the expansion of liquids is greater than solid and expansion of gas is more than liquid.

Volume of water is reducing while heating from 0°C to 4°C. After that volume is increasing. The data at 4°C of water will be taken as reference point for any calculations relating with water.

Heat & Temperature and Pressure - Co-efficient of linear expansion and related problems with assignments

Expansion of solids

A solid substance shows the following types of expansion when heated.

- 1 Linear expansion
- 2 Superficial expansion
- 3 Cubical expansion

1 Linear expansion

When a solid is heated, its length increases. This is called linear expansion. It depends upon the material, original length and change in temperature.

Co-efficient of linear expansion

The co-efficient of linear expansion is the change in length per unit original length per degree rise in temperature. It is represented by α (Alpha).

Length of the solid at $t_1^{\circ}\text{C} = l_1$

Length of the solid at $t_2^{\circ}\text{C} = l_2$

Change in Temperature = $t_2 - t_1^{\circ}\text{C}$

Change in length = $l_2 - l_1$

$$\alpha = \frac{l_2 - l_1}{l_1 \times (t_2 - t_1)}$$

$$\alpha = \frac{l_2 - l_1}{l_1 t} [t_2 - t_1 = t]$$

Co - efficient of linear expansion } = $\frac{\text{Change in length}}{\text{Original length} \times \text{change in temperature}}$

Increased length $l_2 - l_1 = \alpha l_1 t$

Final length $l_2 = l_1(1 + \alpha t)$

2 Superficial expansion

When a solid is heated, its area increases is called superficial expansion.

Co-efficient of superficial expansion

The increase in area per unit original area per degree rise in temperature is called co-efficient of superficial expansion. It is represented by β (Beta).

Co-efficient of superficial

Expansion = 2 x linear expansion

$\beta = 2\alpha$

3 Cubical expansion

When a solid is heated, its volume increases is called cubical expansion.

Co-efficient of cubical expansion

The increase in volume per unit original volume per degree rise in temperature. It is represented by γ (Gama).

Co-efficient of cubical expansion

= 3 x linear expansion

$\gamma = 3\alpha$

Examples

Find the co-efficient of linear expansion. If an 8 metre long metal rod is heated from 30°C to 80°C. So that it may produce an elongation of 0.84 mm.

Initial length (l) = 8m

Increased length = 0.84 mm

Increased temperature(t) = 80 - 30 = 50°C

Co - efficient of linear expansion(α) } = $\frac{\text{Increased length}}{\text{Initial length} \times \text{Increased temp}}$

= $\frac{0.84}{8000 \times 50}$

= $\frac{0.84}{400000}$

= $2.1 \times 10^{-6} /^{\circ}\text{C}$

If iron bridge is 100 metre long at 0°C. What will be the length of bridge if the temperature is 40°C and the co-efficient of linear expansion is 12×10^{-6} per degree.

Initial length of iron bridge = 100 m

Increased temperature = 40 - 0 = 40°C

Co - efficient of linear expansion(α) } = $\frac{\text{Increased length}}{\text{Initial length} \times \text{Increased temp}}$

$12 \times 10^{-6} = \frac{\text{Increased length}}{100 \times 40}$

Increased length = $\frac{12}{1000000} \times 100 \times 40$

= 0.048 m

Iron bridge at 40°C = 100 + 0.048 = 100.048 m

The length of a metal rod is 100 cm at 30°C and 100.14 cm at 100°C. Calculate the co-efficient of linear expansion and the rod length in 0°C.

Initial length at 30°C = 100 cm

Final length at 100°C = 100.14 cm

Increased length = 0.14 cm

Increased temperature = 100 - 30 = 70°C

$$\left. \begin{array}{l} \text{Co-efficient of linear} \\ \text{expansion}(\alpha) \end{array} \right\} = \frac{\text{Increased length}}{\text{Initial length} \times \text{Increased temp}}$$

$$= \frac{0.14}{100 \times 70}$$

$$= \frac{14}{100 \times 70 \times 100}$$

$$= \frac{2}{100000}$$

$$= 2 \times 10^{-5}$$

To find the length at 0°C

$$l_1 = l_0 (1 + \alpha t)$$

$$100 = l_0 (1 + 2 \times 10^{-5} \times 30)$$

$$100 = l_0 (1 + 0.0006)$$

$$l_0 = \frac{100}{1 + 0.0006}$$

$$\text{Length at } 0^\circ\text{C} = 99.94 \text{ m}$$

Find the change in length of metallic rod 100 cm long, when its temperature is increased from 25°C to 40°C and the co-efficient of linear expansion is $10 \times 10^{-6} / ^\circ\text{C}$.

$$\begin{array}{ll} \text{Initial length} & = 100 \text{ cm} \\ \text{Increased temperature} & = 40 - 25 = 15^\circ\text{C} \\ \text{Co-efficient of linear} & = 10 \times 10^{-6}/^\circ\text{C} \\ \text{expansion } (\alpha) & \end{array}$$

$$\left. \begin{array}{l} \text{Co-efficient of linear} \\ \text{expansion}(\alpha) \end{array} \right\} = \frac{\text{Increased length}}{\text{Initial length} \times \text{Increased temp}}$$

$$10 \times 10^{-6} = \frac{\text{Increased length}}{100 \times 15}$$

$$\text{Increased length} = 10 \times 10^{-6} \times 100 \times 15$$

$$= \frac{10 \times 100 \times 15}{1000000}$$

$$= \frac{15}{1000} = 0.015 \text{ cm}$$

Find out the temperature that the rod will extend by 0.54 mm in linear direction when a piece of metal rod is 2.5 metre long in 20°C and the co-efficient of linear expansion is 10.4×10^{-6} per degree centigrade.

$$\text{Initial length} = 2.5 \text{ m} = 2500 \text{ mm}$$

$$\text{Increased length} = 0.54 \text{ mm}$$

$$\text{Initial temperature} = 20^\circ\text{C}$$

$$\begin{array}{l} \text{Co-efficient of linear} \\ \text{expansion } (\alpha) \end{array} = 10.4 \times 10^{-6}$$

$$\left. \begin{array}{l} \text{Co-efficient of linear} \\ \text{expansion}(\alpha) \end{array} \right\} = \frac{\text{Increased length}}{\text{Initial length} \times \text{Increased temp}}$$

$$10.4 \times 10^{-6} = \frac{0.54}{2500 \times \text{Increased temp}}$$

$$\text{Increased temperature} = \frac{0.54}{2500 \times 10.4 \times 10^{-6}}$$

$$= \frac{0.54 \times 1000000}{2500 \times 10.4}$$

$$= \frac{5400}{260} = 20.77^\circ\text{C}$$

$$\begin{array}{l} \text{Final temperature} = 20 + 20.77 \\ = 40.77^\circ\text{C} \end{array}$$

Assignment

Co-efficient of linear expansion

- 1 Calculate the co-efficient of linear expansion of rod. If rod is found to be 100m long at 20°C and 100.14m long at 100°C.
- 2 Find the change in length if the co-efficient of linear expansion of rod is 0.00024/°C and the temperature of a rod of 3.6m length is raised by 120°C,
- 3 Find the change in length if the co-efficient of linear expansion of rod is 0.00024/°C. If the temperature of a rod of 6m length is raised by 120°C,
- 4 Find the increase in length 100 cm iron rod if the temperature raise from 40°C to 90°C. The co-efficient of linear expansion of the iron is $10 \times 10^{-6}/^\circ\text{C}$
- 5 If micrometer reading is standardised at 15°C. What will be the true reading of the micrometer if the reading taken at 35°C is 20.20 mm?
The co-efficient of linear expansion of material of micrometer is $11 \times 10^{-6}/^\circ\text{C}$.

Heat & Temperature and Pressure - Problem of heat loss and heat gain with assignments

Mixing of heat

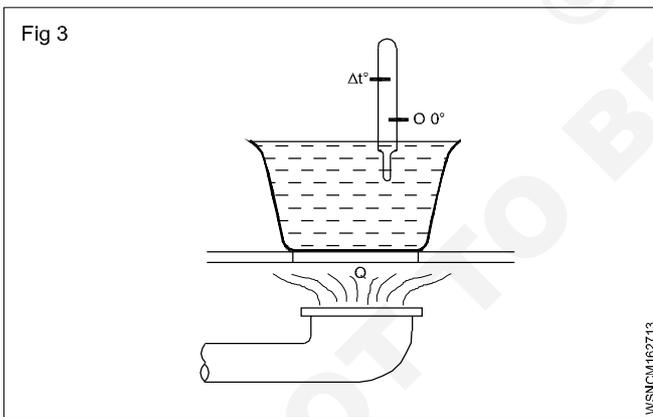
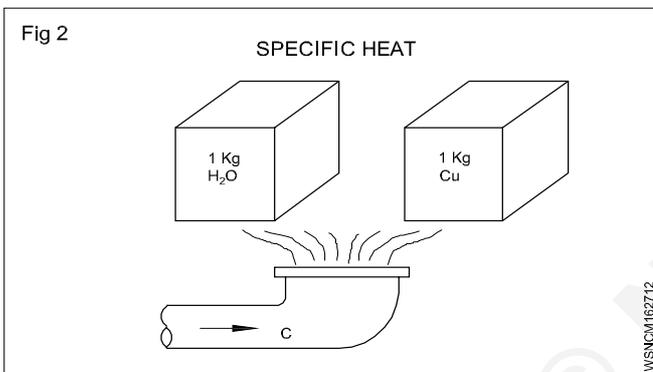
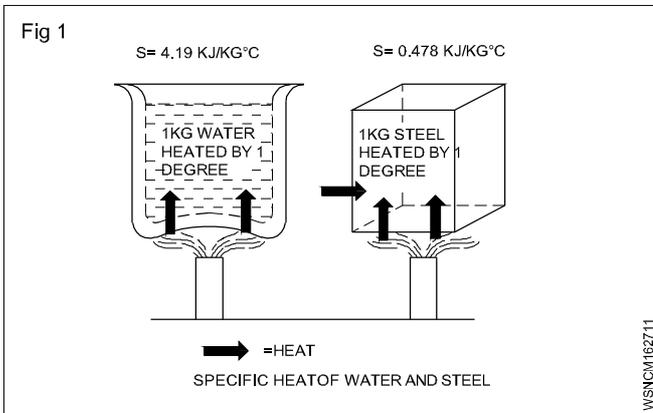

- m_1 - Mass of first substance
- s_1 - specific heat of first substance
- m_2 - mass of 2nd substance
- s_2 - specific heat of 2nd substance
- t_m - temperature of mixture

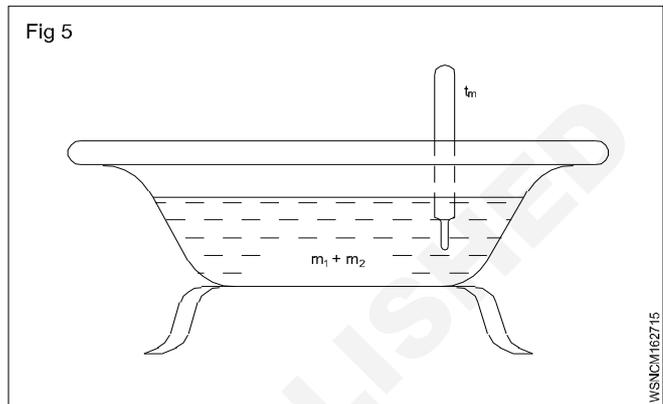

- m - mass
- Q - Quantity of heat
- $\delta t/\Delta t$ - temperature difference
- t_m - temperature of the mixture.

Unit of amount of heat

The derived unit for the amount of heat in S.I. unit is 1 joule (j).

Specific heat

It is also expressed as the amount of heat required to raise the temperature of unit mass of a substance through 1°C. In S.I. unit in order to heat a mass of 1 kg of water through 1°C, the amount of heat needed or the

mechanical equivalent of heat = 4186 joules
 = 4.2 kJ/kg°C.

Quantity of heat needed for a substance to rise the temperature

The amount of heat needed for heating 1 kg of the substance through 1°C is equal to the specific heat of the substance 's'. For heating a mass of 'm' kg of the substance to attain a temperature difference of t,

the quantity of heat needed = $m \times s \times \Delta t$
 Therefore $Q = m \times s \times \Delta t$.

Mixing

When there is an exchange of temperatures, there is an exchange in the amount of heat. When hotter bodies involve with colder substances, heat transference takes place from hotter substances to the colder substances until the mixture or both the substances acquire the same temperature.

Heat lost by the bodies at higher temperature

= Heat gained by the bodies at lower temperature and hence the total amount of heat of the component substances

= amount of heat in the mixture.

$$\begin{aligned} \text{Heat loss by hot substance} &= \\ & \text{Heat gained by colder substance} \\ \text{'S' of the amounts of component heat} &= \\ & \text{amount of heat in the mixture} \\ m_1 \times s_1 \times t_1 + m_2 \times s_2 \times t_2 &= (m_1 s_1 + m_2 s_2) t_m. \end{aligned}$$

Example

A bath tub contains 40 litres of water at 15°C and 80 litres of water at 60°C is poured to it. What is the temperature of the mixture.

$$\begin{aligned} m_1 \times s_1 \times t_1 + m_2 \times s_2 \times t_2 &= (m_1 s_1 + m_2 s_2) t_m \\ \therefore 40 \text{ kg} \times \frac{4.2 \text{ kJ}}{\text{kg}^\circ\text{C}} \times 15^\circ\text{C} + 80 \text{ kg} \times \frac{4.2 \text{ kJ}}{\text{kg}^\circ\text{C}} \times 60^\circ\text{C} \\ &= \left(40 \text{ kg} \times \frac{4.2 \text{ kJ}}{\text{kg}^\circ\text{C}} \times 15 + 80 \text{ kg} \times \frac{4.2 \text{ kJ}}{\text{kg}^\circ\text{C}} \times 60 \right) t_m \end{aligned}$$

$$\text{Temperature of the mixture } t_m = \frac{22680}{120 \times 4.2} ^\circ\text{C} = 45^\circ\text{C}$$

Examples

A container contains 25 kg of water. Initial temperature of container and water is 25°C. Calculate the heat required to heat the water to the boiling temperature of water. Assume water equivalent of container = 1 kg.

Mass of the water (m)	= 25 Kg.	
Initial temperature of water and container	= 25°C	
Final temperature of water and container	= 100°C	
Increased temperature (t)	= 100 - 25	
	= 75°C	
Water equivalent (m s)	= 1 Kg.	
Required amount of heat to container	= m s t	
	= 25 x 1 x 75	
	= 1875 K.cal.	
Required amount of heat to container	= m s t	
	= 1 x 75	
	= 75 K.cal.	
Total required amount of heat	= 1875 + 75	
	= 1950 K.cal.	

300 gram of water at 25°C is mixed with 200 gram of water at 85°C. Find out the final temperature of the mixture assuming that no heat escapes.

i) Weight of water = 300 gram
 Initial temperature = 25°C
 Final temperature = Assume 'X'
 Temperature gained = x - 25°C

ii) Mass of water = 200 gram
 Initial temperature = 85°C
 Temperature lost = 85°C - x

Heat gained by 300 gram water = m s t
 = 300 x 1 x (x - 25)
 = 300 x -7500 cal.

Heat lost by 200 gram water = m s t
 = 200 x 1 x (85 - x)
 = 17000 - 200 x cal.

Heat gained = Heat lost
 300 x -7500 = 17000 - 200 x
 300 x + 200 x = 17000 + 7500
 500 x = 24500
 $x = \frac{24500}{500} = 49^\circ\text{C}$

Final temperature = 49°C

20gm of common salt at 91°C immersed in 250 gram of turpentine oil at 13°C. The final temperature is found to be 16°C. If the specific heat of turpentine oil is 0.428. Calculate the specific heat of common salt.

Mass of the salt(m)	= 20 gram	
Initial temperature(t)	= 91°C	
Mass of the turpentine(m)	= 250 gram	
Initial temperature(t)	= 13°C	
Specific heat of turpentine(s)	= 0.428	
Final temperature of mixture	= 16°C	
Heat gained by turpentine(Q)	= m s t	
	= 250 x 0.428 x (16-13)	
	= 250 x 0.428 x 3	
	= 321 calories.	
Heat lost by salt (Q)	= m s t	
	= 20 x s x (91-16)	
	= 20 x s x 75	
	= 1500 s calories	
Heat lost = Heat gained		
	1500 s = 321	
	$s = \frac{321}{1500}$	

Specific heat of salt = 0.214

Assignment

Mixing of Heat

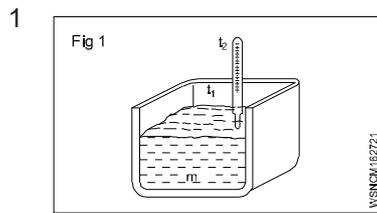

$m = 120$ litres
 $t_1 = 20^\circ\text{C}$
 $t_2 = 85^\circ\text{C}$
 $s = 4.2$
 $Q = \underline{\hspace{2cm}}$ kj

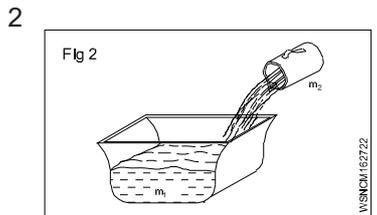

$m_1 = 80$ litres of water
 $m_2 = 40$ litres of water
 $t_1 = 10^\circ\text{C}$
 $t_2 = 70^\circ\text{C}$
 $t_m = \underline{\hspace{2cm}}$ °C

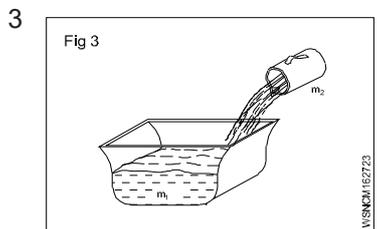

$m_1 = 25$ litres of water
 $t_1 = 12^\circ\text{C}$
 $t_2 = 70^\circ\text{C}$
 $t_m = 33.75^\circ\text{C}$
 $m_2 = \underline{\hspace{2cm}}$ litres

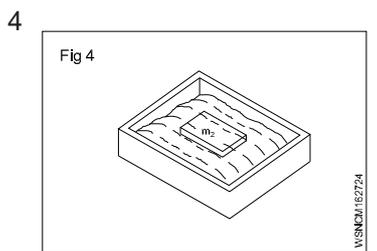

$m_1 = 100$ kg of water
 $t_1 = 12^\circ\text{C}$
 $m_2 = 50$ kg of steel
 $t_2 = 600^\circ\text{C}$
 $S_1 = 4.2 \frac{\text{kJ}}{\text{Kg}^\circ\text{C}}$
 $S_2 = 0.46 \frac{\text{kJ}}{\text{Kg}^\circ\text{C}}$
 Rise in temperature
 $= \underline{\hspace{2cm}}$ °C of water

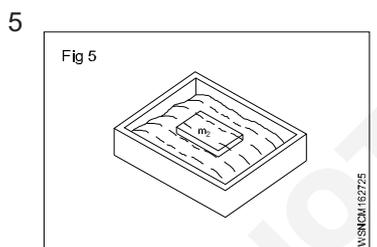

$m_1 = 250$ litres of water
 $m_2 = 150$ kg of steel
 $t_1 = 15^\circ\text{C}$
 $t_m = 70^\circ\text{C}$
 $t_2 = \underline{\hspace{2cm}}$ °C

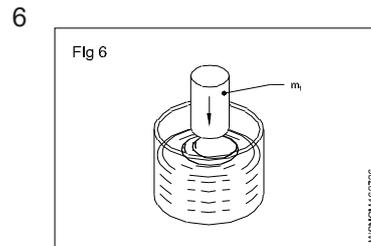

$t_1 = \underline{\hspace{2cm}}$ °C

$m_1 = 20$ litres of machine oil
 $m_2 = 30$ kg of steel
 $t_2 = 160^\circ\text{C}$
 $t_m = 60^\circ\text{C}$
 density of oil
 $= 0.91 \frac{\text{gr}}{\text{cm}^3}$

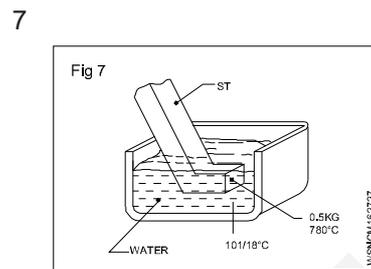

$m_1 = 10$ litres
 $S_1 = 4.2 \frac{\text{kJ}}{\text{Kg}^\circ\text{C}}$
 $S_2 = 0.46 \frac{\text{kJ}}{\text{Kg}^\circ\text{C}}$
 $m_2 = 0.5$ kg
 $t_1 = 18^\circ\text{C}$
 $t_2 = 780^\circ\text{C}$
 Rise in temperature
 $= \underline{\hspace{2cm}}$ °C of water

Heat loss and heat gain

- 1 Calculate the amount of heat required to raise the temperature of 85.5 g. of sand from 20°C to 35°C. Specific heat of sand = 0.1
- 2 How much quantity of heat will be rejected in one hour, if the rate of flow of water is 11 kg/min and the raise of temperature of water is 12°C.
- 3 Find out its specific heat. If we require 510 calories to raise the temperature of 170/ gm of material 50°C to 80°C.
- 4 Calculate the specific heat of metal piece. If 500gm metal piece at 300°C is dropped in 5 kg of water. Its temperature raises from 30°C to 75°C (There is no heat loss).
- 5 Find out the final temperature of mixture, assuming that no heat escapes. If 310gm of water at 20°C is mixed with 210gm of water at 80°C.
- 6 What will be the resultant temperature of the mixture, when 100gm of water at 40°C is added to the mixture. If copper calorimeter contains 80 gm of water at 20°C. The water equivalent of calorimeter is 20 gm.

Heat & Temperature and Pressure - Thermal conductivity and insulators

Insulating materials: Heat will flow from high temperature to low temperature. Heat flow by radiation, conduction and convection method through the wall, door, ceiling and glass door to the refrigerated space.

The material which restricts such heat flow is called insulating materials

Properties of insulating materials

- It has low conductivity
- Resistance to fire
- Less moisture absorption
- Good rigidity
- Odourless
- Vapour permeability
- Light in weight

Selection of insulating material: The following factors are the prime importance in the selection of a proper insulating material.

- **Low thermal conductivity:** Thermal conductance value of a material is a measure of its effectiveness to allow the flow of heat through it by conduction, obviously an insulating material should have a very low thermal conductivity.
- Resistance to fire.
- Mechanical strength
- Low moisture absorption capacity
- Easy to lay
- Cost
- Easy of handling

Low cost

Types of insulating materials

Glass wool, PUF, Cork sheet, Thermocole, Insulating foil, fiber glass.

Types of insulating materials: Basic types of insulating materials are inorganic fibrous or cellular materials. Example, glass wool, slag wool ceramic products, asbestos, etc. Organic fibrous materials, cork, cotton, rubber foam, saw dust, rice husk, polystyrene, polyurethane, phenotherm, etc. The type and form available as the applications of various insulations as follows.

Glass wool: Available as semi-rigid, resin bonded slabs/sheets of different densities -higher density gives strength and lower conductivity but allows vapour transmission. Available with foil or other coverings.

Cork: Compressed and moulded into a rigid block, light but strong, can be cut easily with a saw, resists water but allows relatively high rate of water vapour transmission.

Expanded polystyrene (Thermocole): it is available as a rigid board, beads, moulded into shape for pipe/curved surface, can be cut easily with a saw, light weight allows relatively low vapour transmission.

Polyurethane: available as a rigid board, flexible board, liquid can be sprayed on surfaces and allowed to foam, can be used for in site applications.

Wood shaving/Saw dust: It needs good supporting compartment, can easily settle down. Fairly high conductivity absorbs moisture/water.

Phenotherm: Available slabs with different facings, and as performed pipe sections, can be easily cut with a saw.

Insulating materials and properties/specifications:

There are many insulating materials used in refrigeration and air conditioning field. For our water tank only few of them were in use.

Now-a-days the following insulating materials were in broad use.

- Thermocole
- Glasswool/Tar felt
- Puf
- Fiberglass

Thermocole: It is one of the insulating materials in normal use. It is available in low and high density. This is available in various thicknesses ranging 0.25" to 5".

Thermocole is available in various shapes (moulded) of necessity.

Thermocole allows (Characteristically) low transmission of vapour, thereby heat entry through is cut short. This may vary with its low/high density.

It can be cut very easily even with knife to a required shape. Thermocole withstands cool/heat for a longer time.

The 'K' factor of an insulation material follows (thermocole).

Thermocole -0.20 btu/hr Ft² deg.f°/inch

Fiberglass: Also one of the insulating materials used for is manufactured from inorganic materials (sand, dolomite, limestone). Glass fibre insulation does not shrink due to temperature variation.

This insulation materials used for higher temperatures also upto 450°C (842°F).

Fiberglass products does not absorb moisture from the ambient air.

Glass wool: Normally glass wool material is heavily thin weighted object in layers, soft (touching). It comes off in various sizes (thickness from 0.5" to 2.5". it comes in white, yellow colours mixed up with broken glass pieces.

Handling glass wool is hazardous and harmful (if it is breathed). Always it is advisable to handle glass wool with gloves and goggles (eye) while working on it. It also comes off in various densities.

Glass wools are of two types of uses. One type of glass wool used for low temperature refrigeration/air conditioning purpose. The other type is used for boiler materials (heat prevention) purposes.

The 'K' factor of insulation material:

Glasswool: 0.230-.27 Btu/Hr ft² deg. F°/inch.

Puf: The other mode of insulating materials used in water cooler at the evaporator tank's external body.

For this kind of insulation two chemicals used namely isocyanide-R11., Both available in liquid form in bottles (for lesser capacities) and cans (for higher capacities).

Both the liquids (chemicals) should always kept cool. When both of them added in a container and stirred in few minutes it becomes foamy (initially with thin and becomes thicker and becomes hard (sticks with the unit).

We should be careful that there is no air gap in the tank covered. It foams out with high density and uneven finish at the outer level.

Puf (materials) insulations are widely used by our manufacturer's for their products as it keeps the temperature for a longer period.

The main disadvantage of the insulation is as soon as the chemicals are mixed and stirred it should be poured over the evaporator coil (or) outside the evaporator tank within the shortest period. If the time exceeds the solution starts framing at the container itself and becomes useless.

The evaporator tank should be covered well with wooden/ steel boards with required gaps for insulation tightened all the corners well giving small gaps to pour the solution.

Method of laying duct insulation: when there is no chance of moisture condensation on the duct, glass wool can be used. Since it is economical and fire resistant. However if moisture condensation can occur greater care should be exercised in case of glass wool. First a uniform coat of bitumen is applied to the duct surface and the wool is stuck to the bitumen. The insulation is then covered with a polythene sheet which acts as a vapour barrier. The surface can be plastered after spreading chicken wire mesh as reinforcement.

Expanded polystyrene can be laid easily as it is rigid. Bitumen is applied on the duct and the insulation is stuck joints are also sealed with bitumen. No separate vapour barrier is needed other than a coat of bitumen. The insulation can be finished with cement and plaster or metal cladding.

Purpose of false ceiling: The conditioned air arrives through the ducts at the supply air diffusers and enters the conditioned space. Most diffusers are attached to the false ceiling and a variety of diffusers are available for different air spreading needs. The return air grills will be fixed to the false ceiling. The false ceiling prevents mixing of conditioned air and return air.

Return air usually flow into the plenum or return air box through grill placed in the false ceiling. Since substantial amount of energy goes into the air in the first place. It is a practice to recycle the air. The air is therefore brought back to the air conditioning. Plant room it is common to route the return air through the gap between the false ceiling and the main ceiling. A space referred to as a plenum, the false ceiling is also known as a return air duct.

Heat & Temperature and Pressure - Concept of pressure - Units of pressure, atmospheric pressure, absolute pressure, gauge pressure and gauges used for measuring pressure

Concept of pressure

Continuous physics force exerted on or against an object by something in contact with it.

Definition

Pressure is an expression of force exerted on a surface per unit area, i.e., the force applied is perpendicular to the surface of object per unit area.

$$\text{Pressure} = \frac{\text{Force}}{\text{Area}} = \frac{\text{Newton}}{\text{sq.meter}} = P = \frac{F}{A} \text{N/m}^2$$

As the amount of gas increases assuming the volume of chamber and the temperature remain constant the pressure increases.

Unit: Standard unit and also the S.I. unit of pressure is Pascal (Pa) and Metric unit of pressure is Bar.

1 Pascal is defined as a force of one newton per square metre

i.e., 1 Pascal = 1 N/m²

1 Bar = 10⁵ N/m²

Pressure units in different systems

British unit FPS	Pounds per square inch	lb/in ²
Metric units CGS	Gram per square centimetre	g/cm ²
MKS	Kilogram per square metre	kg/m ²
International unit SI	Newtons per square metre	N/m ²

Types of Pressure

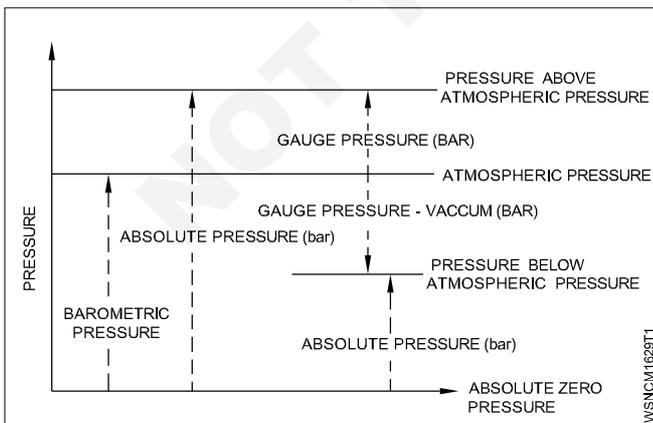

- 1 Absolute pressure
- 2 Atmosphere pressure
- 3 Gauge pressure

Measuring Instruments

- I Manometers
 - a Simple manometer
 - i Piezometer
 - ii 'U' tube manometer
 - iii single column manometer
 - b Differential manometer
 - i 'U' tube differential manometer
 - ii Inverted 'U' tube manometer
- II Mechanical Gauges
 - a Diaphragm pressure gauge
 - b Bourdon's tube pressure gauge
 - c Dead weight pressure gauge
 - d Bellows pressure gauge

Example

A liquid gives force of 100 N over an area of 2m². What is the pressure?

Force = 100 N

Area = 2 m²

Pressure = ?

$$P = \frac{F}{A} = \frac{100}{2} = 50 \text{ N/m}^2$$

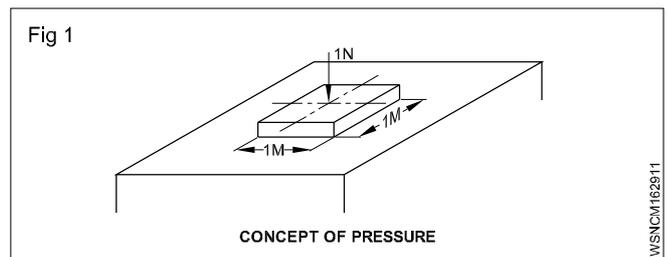

Unit of pressure N/m², 1 N/m² = 1 pascal.

This unit is too small (Pressure of a fly on a area of 1 cm²). Hence 'bar' is introduced as the unit of pressure. 1 bar = 10⁵ pascal.

$$10^5 P_a = 10^5 \frac{\text{N}}{\text{m}^2} = 10 \frac{\text{N}}{\text{cm}^2} = 1 \text{ bar}$$

1 bar = 1000 mbar. [SI unit of Pressure is Pascal (Pa) and Metric unit of Pressure is bar]

Properties of Pressure

- 1 Liquid pressure increase with depth.

- Liquid pressure depends upon the density of the liquid
- The pressure is same in all directions about a point in liquid at rest
- Upward pressure at a point in a liquid is equal to downward pressure

Pascal's Law

A French scientist, Pascal stated that the pressure applied at any point in liquid, at rest is transmitted equally in all directions. This is known as Pascal' law.

Applications of Pascal's law

Pascal's law is applied in many devices like the siphon, hydraulic press, hydraulic lift, brahma press, air compressor, rotary pump and hydraulic brake. These hydraulic machines are based on the principle of transmission of pressure in liquids.

Principle of Hydraulic press

Two cylinders having different cross sectional area are connected to each other by a horizontal connecting tube. The apparatus is filled with a liquid. The two cylinders are fitted with air tight piston .

By giving a small input force on a plunger of a small cross sectional area cylinder a large output force are produced on the ram of large cross sectional area cylinder. According to Pascal's law, small input pressure exerted on plunger is transmitted by the liquid to the ram without any loss. Therefore a small force can be used to lift a much large force or weight. (Fig 2)

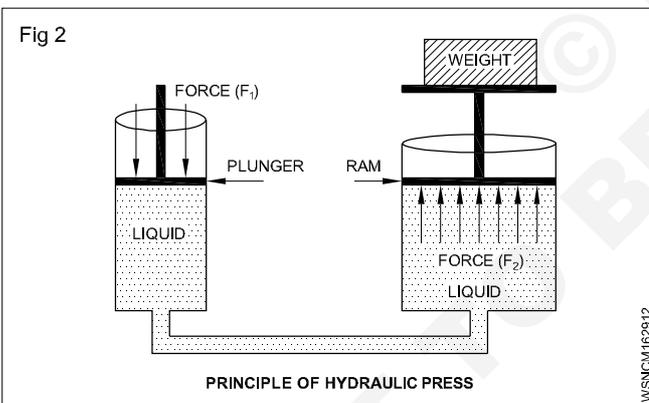

$$\frac{\text{Force on plunger}(F)}{\text{Plunger area}(a)} = \frac{\text{Weight on the ram}(W)}{\text{Ram area}(A)}$$

$$\frac{F}{a} = \frac{W}{A}$$

$$\text{Weight on the ram } (W) = \frac{F \times A}{a}$$

Properties of Air

- Actually speaking, air is a mixture of gases. Air is invisible, colourless, odourless, and tasteless.
- Composition: The main constituents of air by volume are 78% nitrogen, 21% oxygen, and 1% other gases such as argon and carbon dioxide.

- The gaseous layer of air around the earth is known as atmosphere

Pressure Relationship

- Atmospheric pressure :** The air surrounding the earth exerts a pressure on the earth's surface. The pressure prevailing directly on the earth's surface is known as atmospheric pressure.
- The atmospheric pressure is also referred to as reference pressure. Normally it considers the sea level as its reference point.
- The atmospheric pressure may be calculated from the fundamental principle of barometer which states that the barometer reads the pressure due to the height of mercury (Hg) in the tube and its weight.

$$\therefore \text{Atmospheric pressure} = \rho g h$$

Where (rho) ρ = Density of mercury (Hg) = 13600 kg/m³

g = Acceleration due to gravity = 9.81 m/s²,

and

h = height of mercury (Hg) column
= 760 mm of Hg at normal sea level.

Substituting the above values in equation, we get

$$\text{Atmospheric pressure} = 13600 \times 9.81 \times 0.76$$

$$= 1,01,396 \text{ N/m}^2$$

$$= 1.013 \text{ bar}$$

But for easy and simple calculation, we take the atmospheric pressure as 1 bar.

- Absolute pressure:** absolute pressure is defined as the pressure which is measured with reference in absolute vacuum pressure.
- Gauge pressure:** It is defined as the pressure which is measured with the help of a pressure measuring instrument in which the atmospheric pressure is taken as datum. The atmospheric pressure on the scale is marked a zero.
- Vacuum pressure:** It is defined as the pressure below the atmospheric pressure.

Mathematically:

$$\text{i) Absolute pressure} = \text{Atmospheric pressure} + \text{Gauge pressure}$$

$$P_{ab} = P_{atm} + P_g$$

$$\text{ii) Absolute pressure} = \text{Atmospheric pressure} - \text{Vacuum pressure}$$

$$P_{ab} = P_{atm} - P_{vacc}$$

$$\text{iii) Vacuum pressure} = \text{Atmospheric pressure} - \text{Absolute pressure}$$

$$1 \text{ Atmospheric pressure} = 76 \text{ cm of mercury} = 33.91 \text{ ft of water}$$

$$= 76 \times 13.6 \text{ gm/cm}^2$$

$$= 76 \times 13.6 \times 10^{-3} \text{ kg/cm}^2$$

$$= 76 \times 13.6 \times 10^{-3} \times 9.8 \text{ N/cm}^2$$

$$= 10.13 \text{ N/cm}^2$$

$$= 1.013 \text{ bar}$$

= 1013 mbar [1 bar = 1000 mbar]

1 Pascal = 1 N/m²

1 bar = 10⁵ Pascal = 10⁵ N/m² = 10 N/cm²

1 bar = 0.986923 atmosphere

1 millibar = 0.01 N/cm² = 10⁻² N/cm²

1 atmospheric Pressure (FPS) = 14.7 Pound/inch² (psi)

1 atmospheric Pressure (Metric) = 1.0336 Kg/cm²

1 atmospheric Pressure (Metric) = 1.014 x 10⁶ dyne/cm²

Effects of altitude on atmospheric pressure

Atmospheric pressure changes according to altitude a tabulation is shown here with variations.

For every 11 meter above sea level drop in air pressure is 1.3 m bar.

For every 1000 ft above sea level drop in air pressure is 1" Hg (mercury)

S. No.	Place	Unit of Pressure	Mercury column	Inch units
1	Sea level	1013 m bar	750 mm	14.7 psi
2	520 metres above sea level	951.5 m bar	700 mm	13.7 psi

Pressure gauges

They are instruments or devices used to measure the pressure of liquid steam or gas contained in a vessel. There are also known as manometers.

Types of manometers

- Open tube
- Closed tube
- Differential type
- Inverted type

Mechanical pressure gauges

- Bourdon's pressure gauge
- Diaphragm pressure gauges
- Dead weight pressure gauges

Open tube manometer (Fig 3)

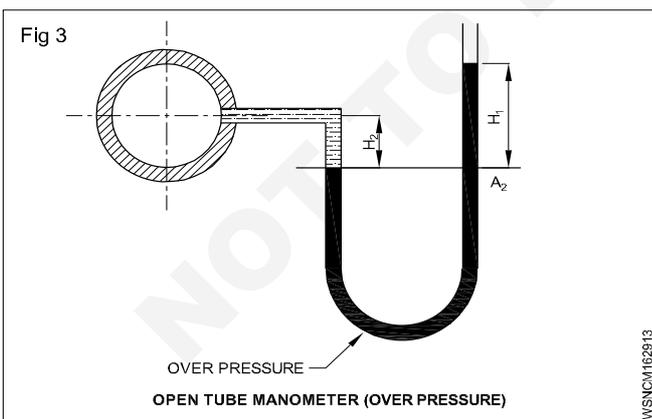

It is more suitable to measure pressure in vessels which is having little variation to atmospheric pressure. It is a 'u' shaped tube containing mercury having its one end connected to the vessel container in which the liquid is there whose pressure is to be determined. The other end is open. The manometer will show a difference in both the limbs of the tube when the pressure inside the vessel is more or less than the air pressure outside.

For a barometer reading with reference to an atmospheric pressure of 1 bar we have

$$P_a = 1 + P_o \text{ (shown in Fig 3)}$$

$$P_a = 1 - P_u \text{ (shown in Fig 4)}$$

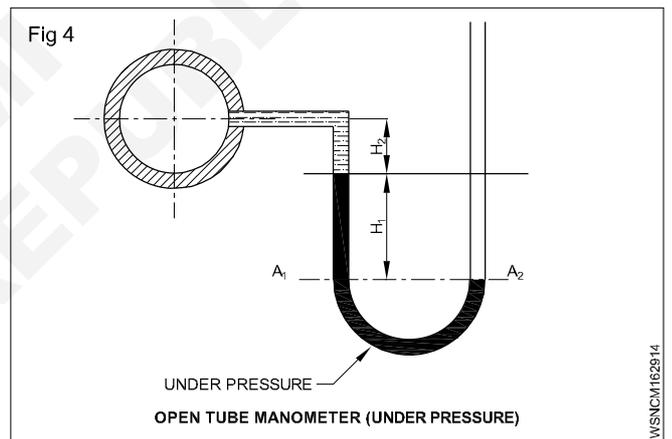

Example (Fig 5)

A manometer is connected to an air pressure tank and it indicates an over pressure of 615 mm pressure head. The external air pressure is 1015 mbar. Calculate the absolute pressure in bar and in Pascal (Fig 5).

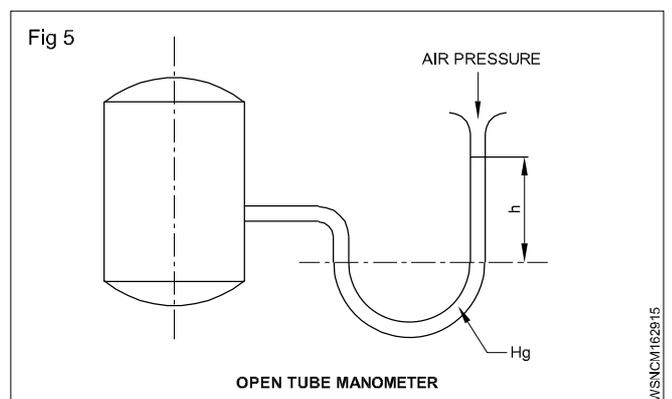

Absolute Pressure = External Air Pressure + Over Pressure

$$P_a = 1015 \text{ mbar} + 100 \text{ mbar} \times 615 \text{ mm} / 750 \text{ mm}$$

$$= 1835 \text{ mbar}$$

$$P_a = 1.835 \text{ bar} = 1.835 \times 10^5 \text{ Pascal}$$

If the barometer reading is in mm, it is always necessary to convert into m bar.

Pressure and Vacuum gauges

Bourdon tube pressure gauges (Fig 6)

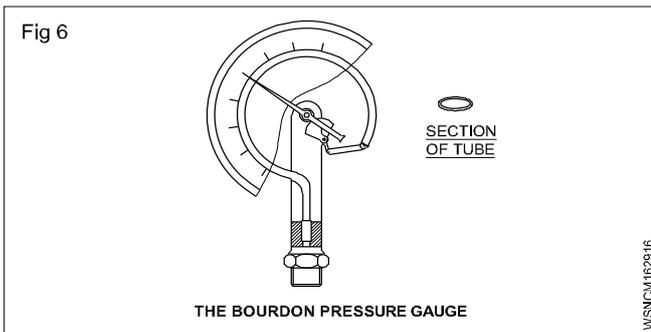

In I.C. Engines, Bourdon tube pressure gauges are widely employed for measurement of pressure, temperature and vacuum. In these gauges, a Bourdon tube which is a tempered, one is used and it attempts to straighten out under pressure and temperature and contract under vacuum.

The working is briefly described here refer to figure. A phosphor bronze tube or elliptical cross section is used and bent to an arc of a circle. The free end of the tube is sealed under internal pressure (or temperature), it attempts to straighten out. During this process, it operates sector, pinion and needle which indicates pressure or temperature over a calibrated dial. The entire unit is mounted on a casing and covered with glass and frame and around it.

Vacuum gauges

These are also of Bourdon tube type gauges where the tube attempts to contract under vacuum thus recording vacuum of the engine in mm Hg (millimeters of mercury)

A reading of 760 mm Hg is perfect vacuum (zero absolute pressure)

A zero of say 300 mm Hg means to say that 300 mm of vacuum is equivalent to (760-300) 460 milliHg absolute pressure.

- Vacuum gauges are often used by service mechanics to find out the mechanical condition of the engine and whether valves, ignition timing and carburetor setting are correct and carry out fine adjustments to obtain the best performance of the engine.
- **Vacuum in Diesel Engine governors:** This is measured by water column methods in fuel injection test bench
- **Vacuum in manifolds of an engine:** This can be measured by using vacuum gauge

- **Over pressure:** The gas pressure of the tyre is bigger than the pressure of the atmosphere. In the tyre we have over pressure.
- **Under pressure :** The gas pressure in the cylinder during the suction process is smaller. There is under pressure in the cylinder.
- **Absolute pressure:** The absolute pressure = air pressure + over-pressure. The pressure in vacuum is 0 bar.

The manometer indicates the over-pressure. The absolute pressure on the earth is normally 1 bar. The measured pressure plus 1 bar is the absolute pressure in normal conditions.

The unit for gas pressure is bar.

$$P_a = \text{absolute pressure}$$

$$P_o = \text{over pressure}$$

$$P_u = \text{under pressure}$$

Air pressure in technical calculations is assumed to be 1 bar.

Rules and examples

Absolute pressure = over pressure + air pressure

$$P_a = P_o + 1 \text{ bar}$$

Over pressure = absolute pressure - air pressure

$$P_o = P_a - 1 \text{ bar}$$

Under pressure = air pressure - absolute pressure

$$P_u = 1 \text{ bar} - P_a$$

Absolute pressure = air pressure - under pressure

$$P_a = 1 \text{ bar} - P_u$$

Examples

- What pressure is 2 bar over pressure?
 $P_a = 2 \text{ bar} + 1 \text{ bar} = 3 \text{ bar}$
- What over pressure is 4 bar?
 $P_o = 4 \text{ bar} - 1 \text{ bar} = 3 \text{ bar over pressure}$
- How many bar under pressure is 0.7 bar?
 $P_u = 1 \text{ bar} - 0.7 \text{ bar} = 0.3 \text{ bar under pressure.}$
- How many bar is 0.3 bar under pressure?
0.7 bar.

Properties of gases

1 Charles's law

First law or law of volume

At constant pressure the volume (V) of a given mass of gas is directly proportional to its absolute temperature(T)

$$V \propto T ; \frac{V}{T} = K \text{ (K - Constant)}$$

Second law or law of pressure

At constant volume the pressure (P) of a given mass of gas is directly proportional to its absolute temperature (T).

$$P \propto T ; \frac{P}{T} = K \text{ (K - Constant)}$$

2 Boyle's law or Gas law

At constant temperature the volume (V) of a given mass of gas is inversely proportional to its pressure. (P)

$$V \propto \frac{1}{P} ; PV = K \text{ (K - Constant)}$$

3 Perfect gas equation

Since boyle's law and charles's law can not be applied independently due to changes in pressure, volume and temperature a combined law called "gas equation" has been formulated. Gas equation is relating to pressure, volume and temperature of perfect gas which obeys both the boyle's law and charles's law. A gas which obeys boyle's and charles's law is called ideal gas.

As per boyle's law

$$V \propto \frac{1}{P} \quad PV = K \text{ (Constant)} \quad P_1 V_1 = P_2 V_2 = K$$

As per charle's law

$$V \propto T \quad \frac{V}{T} = K \text{ (Constant)} \quad \frac{V_1}{T_1} = \frac{V_2}{T_2} = K$$

Combining the above two laws,

$$\frac{P_1 V_1}{T_1} = \frac{P_2 V_2}{T_2} = R \text{ [R = gas constant]}$$

$$\frac{PV}{T} = R$$

$$PV = RT$$

P = Pressure (KN/m²)
V = Volume (m³)
m = Mass (Kg)
R = gas constant (Kgf.m/kg/k)
T = absolute temperature (K)

If mass of the gas is m, then

$$PV = mRT$$

Gas constant R = 29.27 kgf.m / kg/ k

$$= 287 \text{ joule/Kg/k}$$

True gas and its properties

- 1 It has mass and volume. So, it has weight.
- 2 It can be compressed or expanded into a container.
- 3 It is invisible.

4 General Gas Law

Boyle's, Charles', and Gay-Lussac's laws can be combined to obtain the general gas law is given by,

$$\frac{PV}{T} = \text{Constant (or)}$$

$$\frac{P_1 V_1}{T_1} = \frac{P_2 V_2}{T_2} = \frac{P_3 V_3}{T_3} = \dots \dots \dots \frac{P_n V_n}{T_n}$$

In the perfect gas law, the P and T represents absolute pressure and absolute temperature (in °K) respectively.

- 1 1 kg of air at 5 kgf/cm² and 30°C is expanded to atmospheric pressure and 20°C. What will be the volume occupied?

Solution: Assuming atmospheric pressure is 1.033 kgf/cm² and gas constant

$$R = 29.27 \text{ kg m/kg/°K;}$$

$$P_1 = 5 \text{ kgf/cm}^2 = 5 \times 10^4 \text{ kg/m}^2$$

$$T_1 = 30^\circ\text{C} = 30 + 273 = 303^\circ \text{ Kelvin}$$

$$\text{Mass of air} = m = 1 \text{ kg}$$

Applying formula:

$$P_1 V_1 = m.R.T_1$$

$$V_1 = \frac{m.R.T_1}{P_1}$$

$$= \frac{1 \times 29.27 \times 303}{5 \times 10^4}$$

$$= 0.1774 \text{ cubic metre}$$

The following information is ready:

$$P_1 = 5 \times 10^4 \text{ kg/metre}^2$$

$$V_1 = 0.1774 \text{ cubic metre}$$

$$T_1 = 303^\circ\text{K}$$

$$P_2 = 1.033 \text{ kgf/cm}^2 = 1.033 \times 10^4 \text{ kg/metre}^2$$

$$T_2 = 20^\circ\text{C} = 20 + 273 = 293^\circ\text{K}$$

Let V₂ = Volume occupied = To Find

Applying formula:

$$\frac{P_1 V_1}{T_1} = \frac{P_2 V_2}{T_2}$$

$$V_2 = \frac{P_1 V_1 T_2}{P_2 T_1}$$

$$= \frac{(5 \times 10^4) \times 0.1774 \times 293}{(1.033 \times 10^4) \times 303}$$

$$= 0.8303 \text{ cubic metre}$$

Volume occupied = 0.8303 cubic metre

- 2 Find the volume of a gas, if its absolute temperature doubled and the pressure is reduced to one half.

Solution: At initial stage:

$$\text{Let initial pressure} = P_1$$

$$\text{Initial Volume} = V_1$$

$$\text{Initial temperature} = T_1$$

At final stage:

$$P_2 = \text{Final pressure}$$

Since pressure is reduced to one half of initial pressure, we can say

$$P_2 = \frac{1}{2} P_1$$

$$T_2 = \text{Final temperature}$$

Since temperature is doubled, we can say

$$T_2 = 2T_1$$

$$V_2 = \text{Volume of gas required} = \text{To Find}$$

Applying formula

$$\frac{P_1 V_1}{T_1} = \frac{P_2 V_2}{T_2}$$

$$V_2 = \frac{P_1 V_1 T_2}{T_1 P_2}$$

$$= \frac{P_1 V_1 2T_1}{T_1 \frac{1}{2} P_1}$$

$$= 4V_1$$

$$V_2 = 4V_1$$

Final volume = 4 times of initial volume

- 3 Find the pressure at the depth of 40 metres below the surface of a lake in dynes per sq. cm., the atmospheric pressure being neglected.**

Solution:

Depth of water level $\rho = 40 \text{ m} = 4000 \text{ cm}$

Density of water $d = 1 \text{ gram/cc}$

Acceleration due to gravity $g = 980 \text{ cm/sec}^2$

Pressure below the surface of lake is given by the formula
 $= \rho \cdot d \cdot g$.

$$\text{Pressure} = \rho \cdot d \cdot g$$

$$= 4000 \times 1 \times 980$$

$$= \mathbf{3920000 \text{ dynes per sq. cm.}}$$

- 4 At 5 atmospheric pressure 0.2 cu. metre air is filled in a container. If the same air is filled at constant temperature in a 1 cu. metre volume of container then calculate the air pressure in the container.**

Solution: At constant temperature the gas follows Boyle's Law

$$P_1 V_1 = P_2 V_2$$

Here, $P_1 = 5$, $V_1 = 0.2 \text{ cu. metre}$, $V_2 = 1 \text{ cu. metre}$

$$P_1 V_1 = P_2 V_2$$

$$5 \times 0.2 = P_2 \times 1.0$$

$$P_2 = \frac{5 \times 0.2}{1.0} = 1$$

Air pressure in the container = 1 atmospheric.

- 5 The column of mercury in a barometer is 76 cm. If instead of mercury the kerosene oil is filled in the barometer, what would be the state of column when relative density of kerosene oil is 0.8?**

Solution: Suppose the height of column of kerosene in the mercury tube is h_2 , then the pressure of column of kerosene = pressure of column of mercury. Assuming relative density of mercury = 13.6

$$h_2 d_2 g = h_1 d_1 g$$

$$h_2 = \frac{h_1 d_1 g}{d_2 g} = \frac{h_1 d_1}{d_2}$$

$$= \frac{76 \times 13.6}{0.8}$$

$$= 1292 \text{ cm}$$

$$= \mathbf{12.92 \text{ metres}}$$

- 6 The volume of a gas at 770 mm pressure is 403 cc. Find the pressure when the volume is reduced to 341 cc.**

As per Boyles Law

$$P_1 V_1 = P_2 V_2$$

$$770 \times 403 = P_1 \times 341$$

$$P_1 = \frac{770 \times 403}{341}$$

Pressure when volume is reduced = **910 mm**

- 7 At 80 cm pressure the volume of a gas is 800 cu. cm. How much pressure be increased to bring the volume of gas at 200 cu. cm?**

$$\text{Pressure } P_1 = 80 \text{ cm}$$

$$\text{Volume } V_1 = 800 \text{ cu. cm}$$

$$\text{Volume } V_2 = 200 \text{ cu. cm}$$

As per Boyle's law

$$P_1 V_1 = P_2 V_2$$

$$80 \times 800 = P_2 \times 200$$

$$P_2 = \frac{80 \times 800}{200} = \frac{640}{2} = 320 \text{ cm}$$

Pressure to be increased = $320 - 80 = 240 \text{ cm}$

$$= \mathbf{2.4 \text{ metres}}$$

- 8 A gas has a pressure of 2 kg/cm² and volume of 5m³. What will be the volume of gas if the pressure is reduced to 1 kg/cm² keeping the temperature constant?**

$$\text{Gas pressure } P_1 = 2 \text{ kg/cm}^2$$

$$\text{Volume } V_1 = 5 \text{ m}^3$$

$$\text{Pressure } P_2 = 1 \text{ kg/cm}^2$$

As per Boyle's law

$$P_1 V_1 = P_2 V_2$$
$$V_2 = \frac{P_1 \times V_1}{P_2} = \frac{2 \times 5}{1}$$

Volume of gas = 10m³

9 A gas at 1.5 kgf/cm² occupying 0.2 m³ is at 20°C. It is compressed to a pressure of 5 kgf/cm² such that its volume becomes 0.03m³. What will be final temperature of the gas?

Temperature $T_1 = 20^\circ\text{C} = 20 + 273 = 293^\circ\text{ Kelvin}$

Volume of gas $V_1 = 0.2 \text{ m}^3$

Pressure of gas $P_1 = 1.5 \text{ kgf/cm}^2$
 $= 1.5 \times 10^4 \text{ kgf/m}^2$

Volume $V_2 = 0.03 \text{ m}^3$

Pressure $P_2 = 5 \text{ kgf/cm}^2$
 $= 5 \times 10^4 \text{ kgf/m}^2$

As per perfect gas equation

$$\frac{P_1 V_1}{T_1} = \frac{P_2 V_2}{T_2}$$

$$T_2 = P_2 V_2 \times \frac{T_1}{P_1 V_1}$$

$$= 5 \times 10^4 \times 0.03 \times \frac{293}{1.5 \times 10^4 \times 0.2}$$

$$= \frac{439500}{1.5 \times 10^4 \times 0.2}$$

$$= \frac{439500}{3000}$$

$$= 146.5$$

$$T_2 = 146.5 \text{ Kelvin}$$

$$= 146.5 - 273$$

Final temperature of gas = -126.5° C

10 An automobile tyre contains 0.14 kg of air at 2 kg/cm² gauge pressure at 27°C. What is the volume of air in cubic cm?

In this sum gauge pressure is given. To solve it absolute pressure is necessary. Atmospheric pressure = 1.033 kg/cm²

Absolute pressure = Gauge pressure + Atmospheric pressure

$$= 2 + 1.033$$

$$= 3.033 \text{ kg/cm}^2$$

Pressure $P = 3.033 \text{ kg/cm}^2$

$$= 3.033 \times 10^4 \text{ kg/m}^2$$

Weight of air $m = 0.14 \text{ kg}$

Temperature $T = 27^\circ\text{C} = 27 + 273$

$$= 300^\circ\text{ Kelvin}$$

Gas constant $R = 29.27 \text{ kgm/kg/Kelvin}$

(or) 287 Joule / kg/ Kelvin

As per perfect gas equation

$$PV = mRT$$

$$V = \frac{0.14 \times 29.27 \times 300}{3.033 \times 10^4}$$

$$= \frac{1229.34}{30330} = 0.0405 \text{ cu.m}$$

$$= 0.0405 \times 10^6$$

Volume of air = 40532 cu. cm

Assignment

- 1 At 10 atmospheric pressure 0.4 cu. metre air is filled in a container. If the same air is filled at constant temperature in a 2 cu. metre volume of container then calculate the air pressure in the container
- 2 The volume of a gas at 780 mm pressure is 413 cc. Find the pressure when the volume is reduced to 351cc.
- 3 A gas is transferred from one container of volume 100 cc. of a pressure of 1.5 kg/cm² into another container of capacity 200 cc. Find the pressure in the new container.
- 4 5 litre of air at 30°C and 1.1 atmospheric pressure is compressed to one litre and 10 atmospheric pressure. Calculate the temperature after compression.

Basic Electricity - Introduction and uses of electricity, electric current AC,DC their comparison, voltage, resistance and their units

Electricity is a kind of energy. It is the most useful sources of energy which is not visible but its presence can be felt by its effects. Electricity is obtained by conversion of other forms of energy like heat energy, chemical energy, nuclear energy, mechanical energy and energy stored in water etc.,

To understand electricity, one must understand the structure of an atom.

Basically an atom contains electrons, protons and neutrons. The protons and neutrons are located in the centre of an atom and the electrons, a negative electric charge particle revolving around the nucleus in an atom. The proton has a positive charge. Neutrons are neutral and have no charge.

Sources of electricity

Battery

Battery stores electrical energy in the form of chemical energy and it gives power when required. Battery is used in automobiles and electronics, etc.,

Generator

It is a machine which converts the mechanical energy into electrical energy.

When a conductor rotates between a magnetic field using prime mover an emf will be induced. By using this method all types of AC and DC generator - generates power.

- E.g. Thermal power station
Hydro power station
Nuclear power station
Wind power station
Solar power station

Thermo couple

If two dissimilar pieces of metals are twisted together and its joined end is heated in a flame, then a potential difference or voltage will be induced across the ends of the wires. Such a device is known as a Thermo couple. Thermo couple is used to measure very high temperature of furnaces.

Effects of electric current

When an electric current flows through a medium, its presence can be felt by its effects, which are given below.

1 Physical effect

Human body is a good conductor. when the body touches the bare current carrying conductor, current flows through the human body to earth and body gets severe shock or cause even death in many cases.

2 Magnetic effect

When an electric current passes through a coil, a magnetic field is produced around it.

E.g. : Electromagnet Motor, Generator, Electric bell

3 Chemical effect

When an electric current passes through an electrolyte, chemical action takes place. Because of that, an electrical energy is stored in a battery as a chemical energy.

E.g.: Electroplating, Cells and battery charging, refining of metals etc.,

4 Heating effect

When an electric current passes through any conductor, heat is produced in the conductor due to its resistance.

E.g. : Electric heater, Electric iron box, Electric lamp, Geyser, Soldering iron, Electric kettles, Electric welding etc.,

5 X-ray and Laser rays effect

When a high frequency voltage is passed through a vacuum tube, a special type of rays come out, which is not visible. These rays are called x-rays. Laser rays also can be produced by electric current.

6 Gas effect

When electrons pass through a certain type of sealed glass shell containing gas, then it emits light rays.

E.g: Mercury vapour lamp, Sodium vapour lamp, Fluorescent lamp, Neon lamp etc.,

Uses of Electricity

- 1 Lighting - Lamps
- 2 Heating - Heaters, ovens
- 3 Power - Motor, fan
- 4 Traction - Electromotive, lift, crane
- 5 Communication - Telephone, telegraph, radio, wireless
- 6 Entertainment - Cinema, radio, T.V.
- 7 Medical - x-rays, shock treatment
- 8 Chemical - Battery charging, electroplating
- 9 Magnetic - Temporary magnets
- 10 Engineering - Magnetic chucks, welding, x-rays of welding

Classification

- Static electricity
- Dynamic electricity

STATIC ELECTRICITY

If a dry glass rod is rubbed with silk cloth the glass rod gives out negative electrons, and therefore, becomes positively charged. The silk cloth receives negative electrons and therefore it becomes negatively charged. They acquire the property of attracting small pieces of paper etc. because like charges repel and unlike charges attract each other. The electric charge on the silk cloth is stationary and is called static electricity. This type of electricity cannot be transmitted from one place to another.

DYNAMIC ELECTRICITY

The electrons in motion are called current electricity or electric current. This type of electricity is carried through wires and cables. Therefore, this electricity can be transmitted from one place to another. This type of electricity can be produced by cells, batteries, generators alternators etc.

What is the difference between an atom and an element? How are molecules different from atoms? I am often asked these questions in my sessions over and over again and so I finally decided to write a comprehensive post on them. Find answers to all your questions in this section that is designed to help students explore and understand the relationship between atoms, elements, molecules, compounds and mixtures in a manner that is simple and easy to understand.

Types of electric current

- Direct current
- Alternating current

Direct current

In direct current (DC) the direction and magnitude of the current does not change (Fig 2). The steady current flow will be from the positive terminal to the negative terminal. (Fig 3)

Examples

DC Sources : Cells, batteries and DC generators (Fig 3)

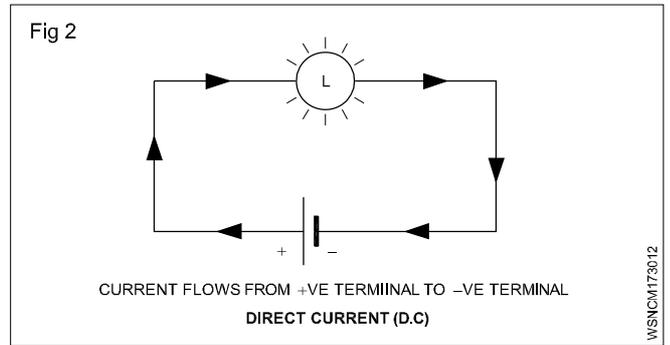
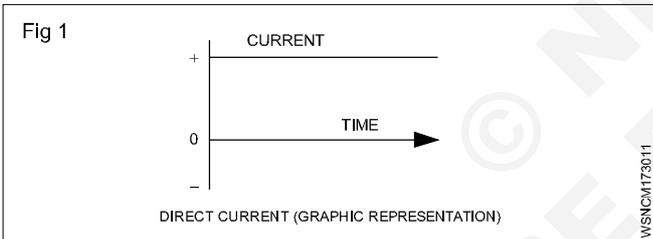

Alternating current (Fig 4)

The current flow will be from the phase terminal to the Neutral terminal. In the alternating current (AC) both the direction and magnitude of the current will be changing at definite intervals of time. The graph shows how an AC current or voltage changes with time. The current increases to the maximum value in one direction, falls to zero and increases to the maximum value in the other (opposite) direction before falling to zero again. Thus a cycle is one complete series of changes. The normal supply frequency is 50 cycles per second.

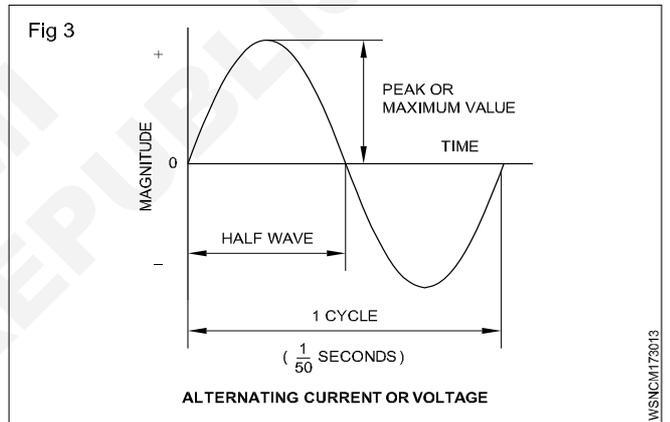

Difference between AC and DC

AC	DC
1 It is generated in the ranges of 6,600 V, 11000 V and 33,000 V.	It is generated up to 6,600 V only
2 Voltage can be stepped up or stepped down by using transformer	It is not possible
3 Transmission cost is less	Cost High
4 Less maintenance	High maintenance
5 Power up to 5,00,000 kw can be generated in a single alternator.	Power up to 10,000 kw can be generated in a single generator
6 AC generator can run at high speeds. So, speed control is not easy.	It can't run at high speeds. Speed control is easy.
7 Slip rings and brushes are used to collect the current.	Commutator and brushes are used to collect the current

Advantages of A.C.

- In transmission there is saving in copper wire.
- Since there is no spark in A.C. machine there is no interference in Radio sound.
- This can be produced to maximum voltage i.e. 33000volts.

- Voltage can be dropped or raised with the help of transformers.
- Its mechanism is simple and cheap.
- Output is more due to availability of more than one phase.

Disadvantages of A.C.:

- A single phase motor is not self-starter.
- Due to thin wire in A.C., the voltage drop is more.
- It cannot be used for electroplating and in charging secondary cells.
- The speed of motors run by it is difficult to change.
- There is danger to security due to high voltage.

Electrical terms and units

Quantity of electricity

The strength of the current in any conductor is equal to the quantity of electrical charge that flows across any section of it in one second. If 'Q' is the charge and 't' is the time taken

$$\text{then } I = \frac{Q}{t} \quad Q = I \times t$$

The SI unit of current is coulomb. Coulomb is equivalent to the charge contained in nearly 6.24×10^{18} electrons.

Coulomb

In an electric circuit if one Ampere of current passes in one second, then it is called one coulomb. It is also called ampere second (As). Its larger unit is ampere hour (AH)

$$1 \text{ AH} = 3600 \text{ As (or) } 3600 \text{ coulomb}$$

Electro motive force (EMF)

It is the force which causes to flow the free electrons in any closed circuit due to difference in electrical pressure or potential. It is represented by 'E.' Its unit is Volt.

Potential difference (P.D)

This is the difference in electrical potential measured across two points of the circuit. Potential difference is always less than EMF. The supply voltage is called potential difference. It is represented by V.

Voltage

It is the electric potential between two lines or phase and neutral. Its unit is volt. Voltmeter is used to measure voltage and it is connected parallel between the supply terminals.

Volt

It is defined as when a current of 1 ampere flows through a resistance of 1 ohm, it is said to have potential difference of 1 volt.

Current

It is the flow of electrons in any conductor is called current. It is represented by 'I' and its unit is Ampere. Ammeter is used to measure the current by connecting series with the circuit.

Ampere

When 6.24×10^{18} electrons flow in one second across any cross section of any conductor, the current in it is one ampere. (or) If the potential difference across the two ends of a conductor is 1 volt and the resistance of conductor is 1 ohm then the current through is 1 ampere.

Resistance

It is the property of a substance to oppose to the flow of electric current through it, is called resistance. Symbol: R, Unit : Ohm (Ω), Ohm meter is used to measure the resistance.

Ohm

If the potential difference across the two ends of conductor is 1 volt and the current through it is 1 ampere, then the resistance of the conductor is 1 Ohm.

Laws of resistance

The resistance offered by conductor depends on the following factors.

The resistance of the conductor

- is directly proportional to the length of the conductor ($R \propto L$)
- Varies inversely proportional to its cross sectional area of the conductor ($R \propto \frac{1}{A}$)
- Depends on the material with which it is made.

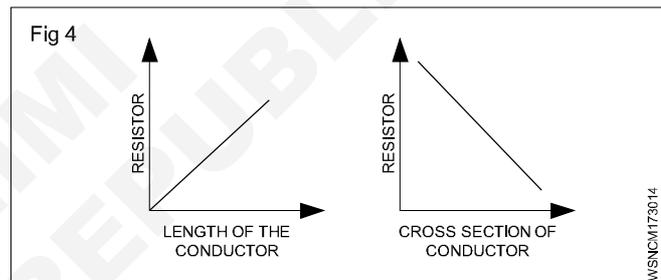

- depends on the temperature of the conductor

$$R \propto L ; R \propto \frac{1}{A} ; R \propto \frac{L}{A} ; R = \rho \frac{L}{A}$$

Specific resistance

The specific resistance of a material is the resistance offered to a current it passed between the opposite faces of the unit cube of the material. Specific resistance is measured in Ohm - m or micro ohm - cm.

Each material has its own specific resistance or resistivity.

E.g. : Copper - $1.72 \mu\Omega \text{ cm}$, Silver - $1.64 \mu\Omega \text{ cm}$, Eureka - $38.5 \mu\Omega \text{ cm}$, Iron - $9.8 \mu\Omega \text{ cm}$, Aluminium - $2.8 \mu\Omega \text{ cm}$, Nickel - $7.8 \mu\Omega \text{ cm}$.

$$R = \frac{\rho l}{A} \text{ ohm cm}$$

R = Resistance in ohms

l = Length of the conductor in cm

ρ = Specific Resistance in ohm cm
(symbol pronounced as rho)

A = Area of cross - section in cm^2

Basic Electricity - Conductor, insulator, types of connections - series and parallel

Conductors

Some materials and metals readily allow passage for electric current to flow. In such materials, called conductors, electrons are able to pass readily from atom to atom.

Properties of conductors

A good conductor should have the following properties.

Electrical properties

- The conductivity must be good.
- Electrical energy spent in the form of heat must be low.
- Resistivity must be low (to reduce voltage drop and loss).
- Increase in resistance with temperature must be low.

Mechanical properties

- Ductility (the property of being drawn into thin wires).
- Solderability: the joint should have minimum contact resistance.
- Resistance to corrosion: should not get rusted when used outdoors.
- Should withstand stress and strain.
- It should be easy to fabricate.

Economical factors

- Low cost.
- Easy availability.
- Easy to manufacture.

Classification of conductors

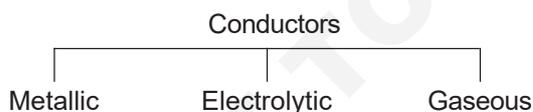

The best conductors are metallic. The commonly used conductors in electrical appliances and machines are described hereunder.

Silver

It is a soft and extremely malleable metal. Even though it is the best conductor, its use is limited because of its high cost.

Copper

It is a very good conductor. It is malleable and ductile, and also has high resistance to corrosion by liquids. Therefore, it is widely used for wires, cables, overhead conductors, bus bars and conducting parts of various electrical appliances.

Aluminium

It is a metal light in weight. It is also ductile, malleable and a good conductor of electricity. Nowadays, it is more widely used (since it is cheaper than copper) for wires and cables. All aluminium conductors (AAC) and aluminium conductors (steel reinforced) (ACSR) are used in overhead and transmission lines. (More details on copper and aluminium are furnished under the topic 'non-ferrous metals and alloys as applicable to electrical trades').

RESISTANCE WIRES

These are conductors with very high resistance for specific applications like filaments of incandescent lamps, heating elements etc. The following are a few examples:

- | | | |
|-----------------|------------|------------|
| 1 Tungsten | 2 Nichrome | 3 Eureka |
| 4 German silver | 5 Manganin | 6 Platinum |
| 7 Mercury | 8 Carbon | 9 Brass. |

The resistance values of the metallic resistances will increase with increase in temperature.

insulators

Description

These are the materials which offer very high resistance to the flow of current and make current flow very negligible or nil. These materials have very high resistance - usually of many megohms (1 megohm = 10^6 ohms) per centimetre cube. The insulators should also possess high dielectric strength. This means that the insulating material should not break down or puncture even on application of a high voltage (or high electrical pressure) to a given thickness.

Properties of insulators

The main requirements of a good insulating material are:

- high specific resistance (many megohms/cm cube) to reduce the leakage currents to a negligible value
- good dielectric strength i.e. high value of breakdown voltage (expressed in kilovolts per mm)
- good mechanical strength, in tension or compression (It must resist the stresses set up during erection and under working conditions.)
- little deterioration with rise in temperature (The insulating properties should not change much with the rise in temperature i.e. when electrical machines are loaded.)
- non-absorption of moisture, when exposed to damp atmospheric condition. (The insulating properties, specially specific resistance and dielectric strength decrease considerably with the absorption of even a slight amount of moisture.)

Classification of insulators (Fig 1)

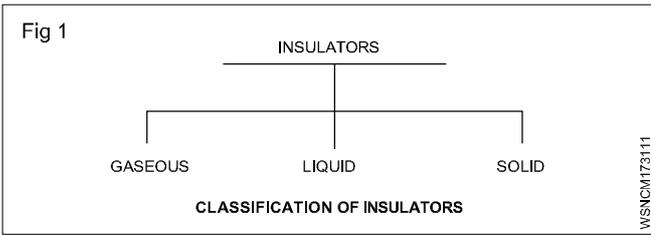

Air is an example of a gaseous insulator. Other examples are hydrogen, nitrogen and inert gases.

Liquid insulators

Mineral oils, synthetic liquids, resins and varnishes are the liquid insulators.

Transformer oil

In transformers the oil is used as an insulator and also for cooling of the transformer windings by convection. Therefore, the transformer oil should be dry and purified, since the presence of moisture will reduce the dielectric strength of the oil.

Purpose of transformer oil

- Transfer of heat by convection, from winding and core to the cooling surfaces.
- It maintains the insulation of winding and also extinguishes fire that occurs due to faults occurring in the windings.

Precaution

The insulating value of a transformer oil is reduced due to the formation of sludge as a result of oxidation due to air and temperature. To minimise oxidation, the oil should not be exposed to air.

Sludge is also formed due to the presence of acids and alkalis.

Sludge formation

- Reduces the rate of heat transfer.
- Blocks the ducts.
- Increases the operating temperature.

To prevent moisture from entering the oil, the whole apparatus is made airtight, and calcium chloride, silicagel fillets are used.

Testing of transformer oil as per ISI Standard (Fig 2)

Dielectrical strength test (Refer to Fig 2): The oil should be 40 mm above and 40 mm below the electrodes. The gap between the two electrodes should be kept at $4\text{ mm} \pm 0.02\text{ mm}$.

A high voltage is applied across the electrodes through a step-up transformer, and increased till there is a spark in between the electrodes. The voltage noted on the voltmeters, when the spark occurs, is the breakdown voltage or dielectric strength of the oil. This is the maximum voltage the oil can withstand.

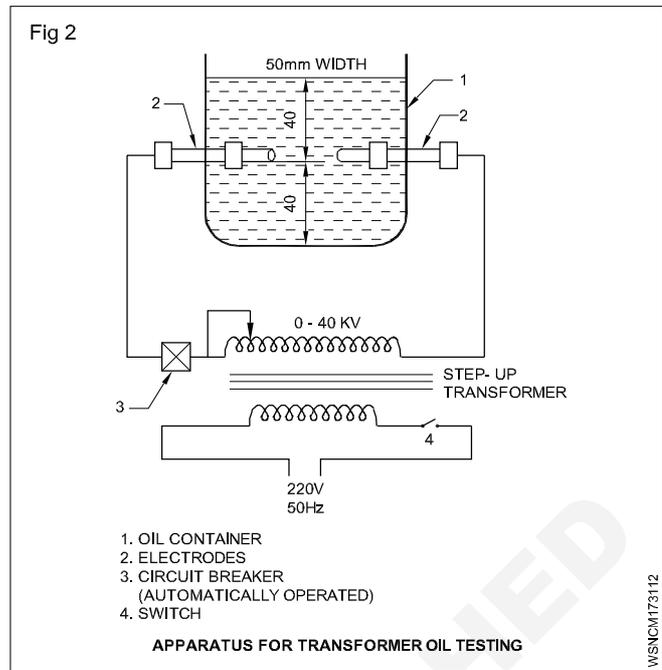

According to ISI specifications, the oil should be able to withstand 40 kV for one minute with a gap ($4\text{ mm} \pm 0.02\text{ mm}$) between the electrodes and with the diameter of the electrodes as 13 mm.

Moisture test : In this test, an oil sample is cooled in a closed vessel down to $15\text{--}25^\circ$. A dry test tube, 12.5 mm in diameter and 125 mm long, is taken and an adequate quantity of oil is poured into it.

The tube containing the oil is heated rapidly with the help of an electric heater till the oil begins to boil. During the process, oil should not produce cracking.

The other tests are:

- acidity test
- sludge resistance test.

Electrical insulating varnishes

They are of two types

Oil and resin varnishes.

Solid insulators/insulating materials

Sl. No.	Classification	Examples
1	Mineral insulators	Mica, marble, slate.
2	Vitreous materials	Glass, quartz, procelain.
3	Rubber and rubber products	Rubber, vulcanised (India) rubber (V.I.R) ebonite
4	Waxes and compounds	Paraffin wax, bitumen.
5	Fibrous materials	Asbestos, paper, wood, Press pahn, leatheroid, cotton, silk, tapes etc.
6	Synthetic products	Bakelite, shellac, oil (for Transformer, Switchgear etc).

Paper

Various grades of insulating paper are available for use in capacitors, cables, etc. Paper, if moist, loses its insulating property. Therefore, it is used in an impregnated condition.

Wood

It is impregnated with oil or other substance for use as an insulator.

For example, in machine windings, bamboo wood is used as slot wedges.

Press board

It is widely used in windings to insulate parts which support windings. It is also used as spacers in electrical devices and transformers.

Asbestos

A fibrous, incombustible, fire-proof material - used for panel boards and as frames for winding resistance wires of regulators, rheostats etc.

Cotton

It is soaked in paraffin to avoid moisture. It is a good insulator for low voltages. It is used in conductors for armatures and field coils.

Silk

Like cotton, it is used for small jobs like telephone coils.

Tapes

Tapes of various types are used, such as cotton, silk, jute etc either pure or in impregnated form.

Empire cloth

It is made by varnishing a cotton cloth, silk or paper. It is not effected by moisture. It is available in yellow and black colours in different sizes. It is used as slots insulation in winding works and for coil insulation.

Press pahn

Press pahn is a form of paper made from hemp, rags, and wood pulp by special chemical treatment. It is widely used for lining armature slots, insulating coil sides, etc.

Leatheroid

It is a tough material made from cotton rags with chemical treatment. It is unaffected by grease or oil and is used for slot and coil insulation, transformer core coverings, etc.

Adhesive tape

It is used widely for taping of ends of conductors, leads and connections. Adhesive tape is made from cotton fabric coated with a compound of rubber, bitumen, resin, gum,

etc. It dries when exposed to air. It is available in sizes $\frac{1}{2}$, $\frac{3}{4}$ ", 1" etc. These are also available as P.V.C. adhesive tape, cotton and bitumen tapes.

Bitumen

It is used for filling cable jointing boxes and for sealing the tops of the batteries etc. It is waterproof, but it will crack

under certain conditions. It can be vulcanised in the same manner as rubber.

Mica

It is a mineral and available as large slabs. It can be easily separated into thin sheets. It is fireproof, waterproof, and is a good insulator. It should be used carefully since it is liable to crack. It is used in heating elements of electric iron etc.

Marble and slate

Marble and slate are mechanically strong insulators and are non- hygroscopic. When polished they form good mountings for switchboards, switches, resistance frames, etc. Slate is used generally for low voltages.

Micanite

It is made by sticking together pieces of mica with insulating cement like shellac. It can be bent to any shape by heating and pressing. Therefore, it is used as insulator for slots of armatures and to insulate the commutator from the shaft.

Paraffin wax

It melts at 55°C and does not absorb water. It is used to impregnate paper, wood, pressboard etc to reduce their moisture absorption.

Bakelite

It can be moulded to any shape. It is heat-resistant and highly insulating. It will not absorb oil and moisture. It is used for bodies of switches, plugs, holders, regulators etc.

Rubber

It has high insulating properties. It is used mainly on lighting cables and for flexible cables. It deteriorates gradually when exposed to atmosphere. Rubber is being replaced now by elastic plastics such as PVC or polyethylene which can resist alkalis, acids and mineral oils.

Valcanised India Rubber (VIR)

This is manufactured by treating pure rubber with sulphur. It is stronger than pure rubber and is not affected much by change in temperatures. It is used as coverings for low and medium voltage wires and cables.

Ebonite or vulcanite

Ebonite or Vulcanite is vulcanised rubber containing about 30% to 50% of sulphur, and subjected to a prolonged heating at 150°C. The material is hard and can be moulded into different shapes. It is less affected by chemicals and moisture. It is used for making containers of lead acid batteries, cases for instruments and switchgears, terminal plates and low voltage panel boards etc. It should not be subjected to heat.

Shellac

It is a good varnish which is used to improve the insulation and moisture resisting properties of paper, cloth, wood, slate etc.

Enamel

By this, an insulation coating is given on winding wires.

Polychloroprene (PCP)

It is a plastic material used for insulation of cables. It is resistant to oil and petrol. It can be used in conditions of exposure to sulphur fumes, steam, ammonia, lactic acid and direct sunlight.

Glass

It is heat-resistant and suitable for high temperatures. It is used as insulators, envelopes for lamps, radio tubes etc.

Quartz

Quartz (Silica) is a good insulator. As it has a very low temperature coefficient of expansion, it does not crack with sudden variations in temperature. It is used for pyrometer sheaths, for heating elements, sparking plugs, etc.

Porcelain

Porcelain is not so brittle as glass and is very widely used for carrying bare conductors, for making fuse carriers and other electrical fittings.

Red fibre

Mainly used in motor and transformer winding work, for slot insulation, separators etc.

Insulators classified according to their temperature limits

The permissible temperature limit at which the insulators may be worked safely without deterioration, depends upon the type and class of the insulation as detailed below. (IS:1271/1958)

Class Y – maximum temperature 90°C

Cotton, silk, paper products, press board, wood, vulcanised fibre - not impregnated or immersed in oil.

Class A – maximum temperature 105°C

Cotton, silk, paper products, wood, vulcanised fibre when impregnated or immersed in liquid dielectric, varnished paper and wire enamel (class A).

Class E – maximum temperature 120°C

Wire enamel, cotton fabric and paper laminates treated with oil, modified asphalt and synthetic resins, varnished polyethylene, textile treated with suitable varnish.

Class B – Maximum temperature 130°C

Glass fibre, asbestos, varnished glass fibre, textile, varnished asbestos, built up mica treated with synthetic resin varnishes.

Class F – maximum temperature 155°C

Similar to class B materials but treated with silicone resins.

Class H – maximum temperature 180°C

Same as class F materials but treated with silicone resins of higher thermal stability than class F.

Class C – maximum temperature above 180°C

Mica, porcelain and other ceramics, glass, quartz, asbestos, treated glass fibre textile, treated asbestos, built up mica treated with silicone resins possessing superior thermal stability (limited stability up to 225°C).

Series Connection

The total resistance is equal to the sum of all the resistances. In a series connection the end of the first load is connected to the beginning of the second load and all loads are connected end to end. (Fig 3)

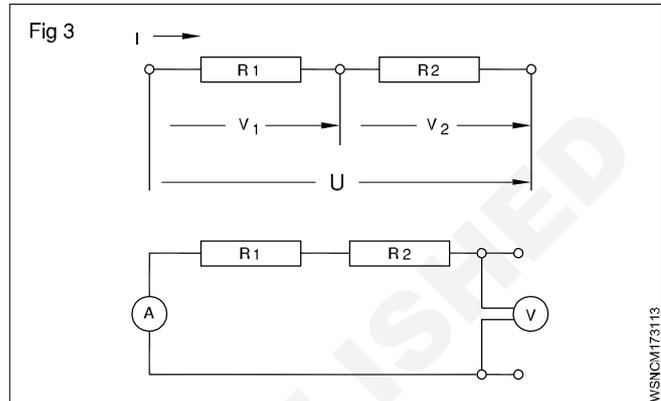

Features of series connection:

- The same current flows through all the loads.
- The voltage across each load is proportional to the resistance of the load.
- The sum of the voltages across each load is equal to the applied voltage.
- The Total resistance is equal to the sum of all the resistances.

$$I = I_1 = I_2 = \dots$$

$$V = V_1 + V_2 + \dots$$

$$R = R_1 + R_2 + \dots$$

Example

Three resistances of 3 ohms, 9 ohms and 5 ohms are connected in series. Find their resultant resistance.

Solution

$$\begin{aligned} R &= R_1 + R_2 + R_3 \\ &= 3 \Omega + 9 \Omega + 5 \Omega \end{aligned}$$

$$\text{Total resistance} = 17 \Omega$$

Parallel connection

In a parallel connection the beginning and the ends of the loads are connected together.

Features of parallel connection:

- The current flowing through each load depends upon the resistance of the load.
- The voltage across each load is the same and is equal to the voltage applied to the circuit.

Fig 4

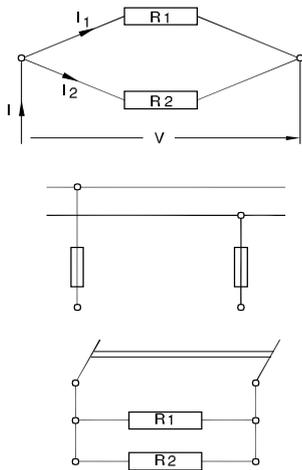

WSN/M173114

- The total resistance of a parallel connection is always smaller than the smallest resistance in the circuit.
- In parallel connection the reciprocal of the total resistance is equal to the sum of the reciprocals of all resistances in the circuit.

$$I = I_1 + I_2 + \dots$$

$$V = V_1 = V_2 \dots$$

$$\frac{1}{R} = \frac{1}{R_1} + \frac{1}{R_2} + \dots$$

Example

Two resistances of 4 ohms and 6 ohms are connected in parallel. Determine the total resistance.

$$\frac{1}{R} = \frac{1}{R_1} + \frac{1}{R_2} + \dots \quad (\text{since parallel connection})$$

Therefore $\frac{1}{R} = \frac{1}{4} + \frac{1}{6} = \frac{10}{24} = \frac{5}{12}$

Therefore $R = \frac{24}{10}$ ohms = 2.4 ohms

Example

Two resistors of 2 and 4 ohms are switched in parallel to a 6V battery

- Calculate the total resistance
- Find the total current and partial current.

Fig 5

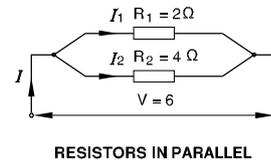

WSN/M173115

Solution

Total resistance

$$\frac{1}{R_{tot}} = \frac{1}{R_1} + \frac{1}{R_2}$$

$$= \frac{1}{2} + \frac{1}{4} = \frac{2+1}{4}$$

$$= \frac{3}{4} \Omega$$

$$R_{tot} = \frac{4}{3} = 1\frac{1}{3} \Omega$$

I Total = I₁ + I₂ current

But $I_1 = \frac{U}{R_1} = \frac{6V}{2\Omega} = 3A$

$$I_2 = \frac{U}{R_2} = \frac{6V}{4\Omega} = 1.5A$$

I total = 3A + 1.5A
= 4.5 Amp

Basic Electricity - Ohm's law, relation between V.I.R & related problems

Ohm's law

V - Voltage in volts

I - Current in Ampere

R - Resistance in ohms.

In any closed circuit the basic parametres of electricity (Voltage, Current and resistance) are in a fixed relationship to each other.

Basic values

To clarify the basic electrical values, they can be compared to a water tap under pressure

Water pressure	- electron pressure	- Voltage
Amount of water	- electron flow	- Current
throttling of tap	- obstruction to electron flow	- Resistance

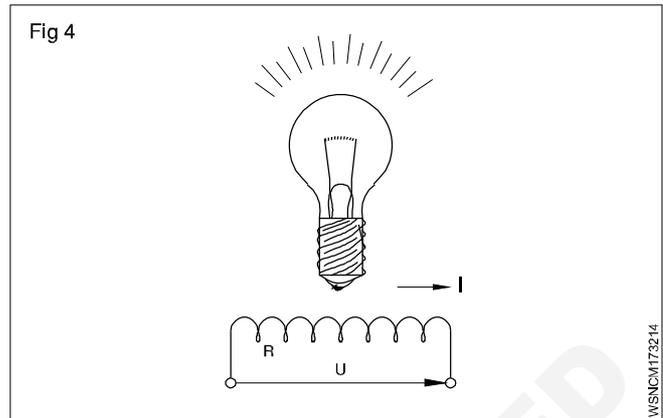
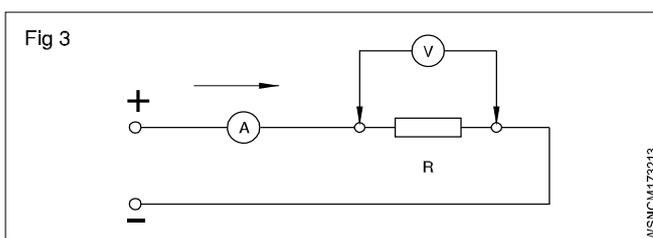
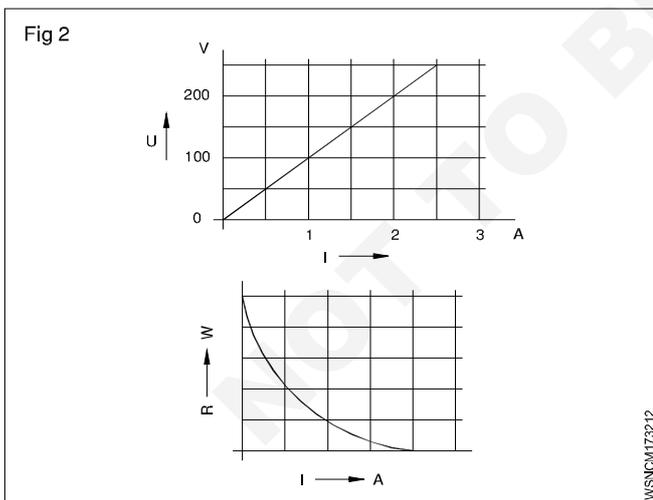
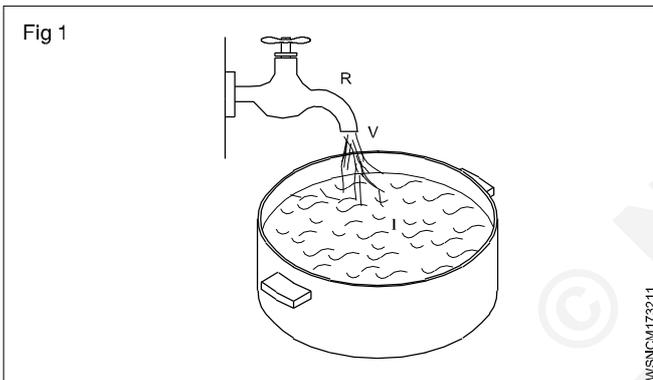

Relationships

If the resistance is kept constant and the voltage is increased, the current is increased

$$I \propto V$$

If voltage is constant and the resistance is increased, current is decreased

$$I \propto \frac{1}{R}$$

Ohm's law

From the above two relationships we obtain Ohm's law,

$$I = \frac{V}{R} \text{ which is conveniently written as } V = R.I.$$

Ohm's law states that at constant temperature the current passing through a closed circuit is directly proportional to the potential difference, and inversely proportional to the resistance.

By Ohm's law $I = \frac{V}{R}$

EXAMPLE

A bulb takes a current of 0.2 amps at a voltage of 3.6 volts. Determine the resistance of the filament of the bulb to find R. Given that V = 3.6 V and I = 0.2 A.

To find 'R'. Given that V = 3.6V and I = 0.2 A

Therefore $V = I \times R$
 $3.6 \text{ V} = 0.2 \text{ A} \times R$

Therefore $R = \frac{3.6V}{0.2A} = 18 \text{ ohms}$

Example

The voltage supply to a filament lamp is 10.8V. The voltage should be 12V. Find out loss of voltage.(Fig 5)

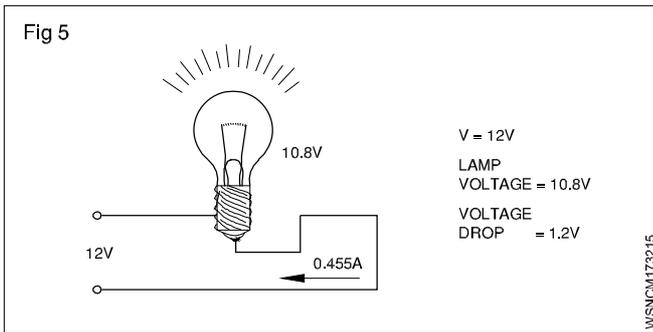

Voltage drop = 12V – 10.8 = 1.2V

The supply voltage is called Potential difference.

Example

The Internal resistance of a dynamo is 0.1 ohm. The voltage of dynamo is 12V. What is the Voltage of dynamo when a current of 20 amps being supplied to an outside circuit.

Solution

Voltage drop = Current x Internal resistance
 = 20 x 0.1 volts
 = 2 volts

Example (Fig 6)

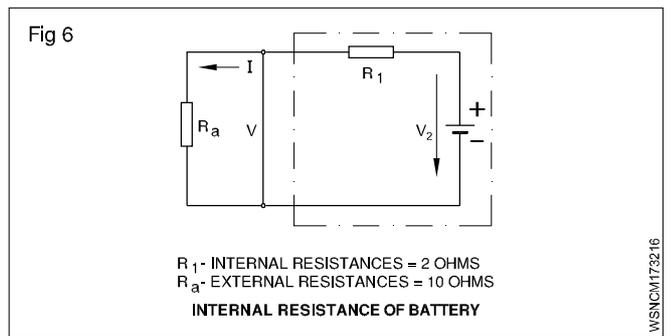

The Internal resistance of a Battery is 2 ohms. When a resistance of 10 ohms is connected to a battery it draws 0.6 amps. What is the EMF of the battery.

P.D = Current flowing x Resistance

= 0.6 A x 10Ω

= 6 volts

V.D = Current flowing x Internal resistance of battery

= 0.6 x 2 volts

= 1.2 volts

EMF of the Battery = (6.00 + 1.2)V

= 7.2 volts

Resistance connections

V - Voltage (in volts)

R - Resistance (in ohms)

I - Current intensity (in Amperes)

Assignment

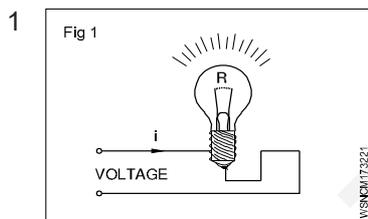

R = 40 Ohms
 I = 6.5 Amps
 V = _____ Volts

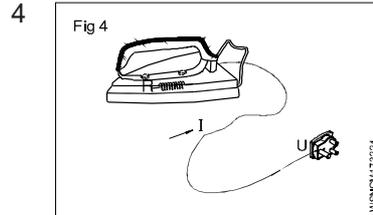

I = 4.5 Amps
 V = 220 Volts
 R = _____ Ohms

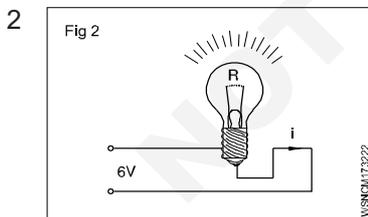

V = 6 Volts
 I = 0.5 Amps
 R = _____ Ohms

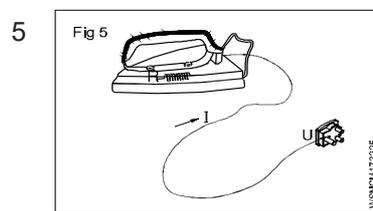

R = 50 Ohms
 V = 220 Volts
 I = _____ Amps

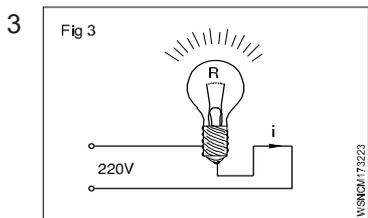

V = 220 Volts
 R = 820 Ohms
 I = _____ Amps

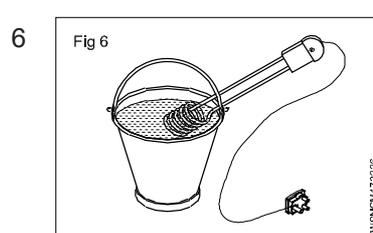

V = 110 Volts
 I = 4.55 Amps
 R = _____ Ohms

Basic Electricity - Electrical power, energy and their units, calculation with assignments

Electric Power

In mechanical terms we defined power as the rate of doing work. The unit of power is Watt. In an electrical circuit also the unit of electrical power is 1 Watt. In mechanical terms 1 Watt is the work done by a force of 1 N to move the body through 1 metre in one second. In an electrical circuit, the electromotive force overcomes the resistance and does work. The rate of doing work depends upon the current flowing in the circuit in amperes. When an e.m.f of one volt causes a current of 1 ampere to flow the power is 1 Watt.

Hence Power = Voltage x Current

$$P = V \times I$$

Power in Watts = Voltage in Volts x Current in Amperes

Electric work, energy

Electrical work or energy is the product of electrical power and time

Work in Watt seconds = Power in Watts x time in sec
 $W = P \times t$

Since 1 joule represents 1 Watt x 1 sec, which is very small, larger units such as 1 Watt hour and 1 kilowatt hour are used.

$$1 \text{ W.h} = 3600 \text{ Watt sec.}$$

$$1 \text{ Kwh} = 1000 \text{ Wh} = 3600000 \text{ Watt sec}$$

FPS System

$$1 \text{ HP} = 746 \text{ watts}$$

$$= 0.746 \text{ K.W}$$

Metric System

$$1 \text{ HP} = 735.6 \text{ watts}$$

$$= 0.7356 \text{ K.W}$$

Note: The charge for electric consumption is the energy cost per Kwh and it varies according to the country and states.

Fig 1

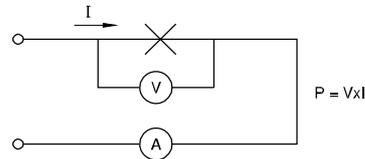

V - Voltage (Volts) V

i - Current Intensity (Amperes) A

P - Power (Watts, Kilowatts) W, kW

W - Work, Energy (Watt hour, Kilowatt hour) wh, Kwh

t - time (hours) h

Fig 2

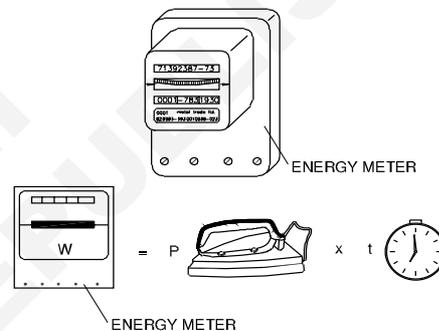

Table of analogies between mechanical and electrical quantities

Mechanical quantity	Unit	Electrical quantity	Unit
Force 'F'	N	Voltage 'V'	V
Velocity $v = \frac{\text{Displacement}}{\text{Time}}$	m/s	Current I	A
Time t	seconds	Time t	seconds
Power $P = F \times v$	$N \frac{m}{sec}$	Power $P = V \times i$	$W = V \times A$
Energy = $F \times v \times t$	$j = Nm$	Energy $W = V \times i \times t$	$j = W \times s$

$$W = VI$$

$$= I^2R$$

$$= \frac{V^2}{R}$$

$$R = \frac{V}{I}$$

$$= \frac{V^2}{W}$$

$$= \frac{W}{I^2}$$

$$V = IR$$

$$= \frac{W}{I}$$

$$= \sqrt{WR}$$

$$I = \frac{V}{R}$$

$$= \frac{W}{V}$$

$$= \sqrt{\frac{W}{R}}$$

Example

- 1 Calculate the power rating of the lamp in the circuit, if 0.25 amperes of current flows and the voltage is 240 volts.**

$$P = V \times I$$

$$V = 240 \text{ Volts}$$

$$I = 0.25 \text{ Ampere}$$

$$\begin{aligned} \text{Therefore Power} &= 240 \text{ Volts} \times 0.25 \text{ Amperes} \\ &= 60 \text{ Volts Ampere} \end{aligned}$$

$$\text{But } 1 \text{ Watt} = 1 \text{ Volt} \times 1 \text{ Ampere}$$

$$\text{Therefore Power} = 60 \text{ Watts}$$

- 2 A current of 15 amperes flow through a resistance of 10 Ohms. Calculate the power in kilowatts consumed.**

$$\text{Given that } R = 10 \text{ and } I = 15 \text{ A}$$

$$\text{Power} = V \times I = I \times R \times I = I^2 \times R$$

$$\text{Therefore Power} = 15^2 \times 10 = 2250 \text{ Watts} = 2.25 \text{ kW}$$

- 3 At a line voltage of 200 Volts a bulb consumes a current of 0.91 amperes. If the bulb is on for 12 hour calculate the work in Wh to find the work given that V = 200 Volts.**

$$I = 0.91 \text{ Amps.}$$

$$t = 12 \text{ hours}$$

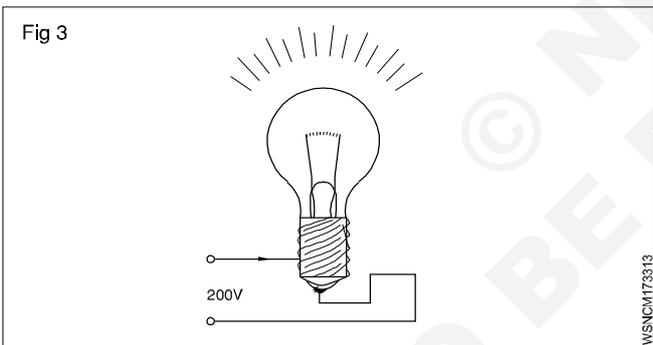

$$\begin{aligned} \text{Therefore Power} &= V \times I = 200 \text{ Volts} \times 0.91 \text{ Amps} \\ &= 182 \text{ Watts} \end{aligned}$$

$$\begin{aligned} \text{Therefore Work} &= P \times t = 182 \text{ Watts} \times 12 \text{ hours} \\ &= 2184 \text{ Watt hour.} \end{aligned}$$

- 4 An adjustable resistor bears the following label: 1.5 k Ohms/0.08 A. What is its rated power?**

$$\text{Given: } R = 1.5 \text{ k Ohms; } I = 0.08 \text{ A}$$

Find: P

$$V = R \times I = 1500 \text{ Ohms} \cdot 0.08 \text{ A} = 120 \text{ volts}$$

$$P = V \times I = 120 \text{ volts} \cdot 0.08 \text{ A} = 9.6 \text{ W alternatively:}$$

$$P = I^2 \cdot R = (0.08 \text{ A})^2 \cdot 1500 \text{ Ohms} = 9.6 \text{ W.}$$

- 5 Find the current and power consumed by an electric iron having 110Ω resistance when feed from a 220 v supply**

$$\text{Resistance of electric iron (R)} = 110 \text{ ohms}$$

$$\text{Voltage (V)} = 220 \text{ volts}$$

$$\begin{aligned} \text{Current (I)} &= \frac{V}{R} \\ &= \frac{220}{110} = 2 \text{ amperes} \\ \text{Power (w)} &= V \times I \\ &= 220 \times 2 \\ &= 440 \text{ watts} \end{aligned}$$

- 6 Find the total power if four 1000 W, 180 volt heaters are connected in series across 240 V supply and current carrying capacity is 15 amp. Find the total power.**

$$\text{Connection} = \text{Series}$$

$$\text{No. of heaters} = 4$$

$$\text{Heater power (W)} = 1000 \text{ watts}$$

$$\text{Heater voltage} = 180 \text{ V}$$

$$\text{Supply voltage} = 240 \text{ V}$$

$$\begin{aligned} \text{Heater resistance (R)} &= \frac{V^2}{W} \\ &= \frac{180 \times 180}{1000} = \frac{324}{10} \\ &= 32.4 \text{ ohms} \end{aligned}$$

$$\text{Total resistance} = 32.4 \times 4 = 129.6 \text{ ohms}$$

$$\begin{aligned} \text{Total current (I)} &= \frac{V}{R} \\ &= \frac{240}{129.6} = 1.85 \text{ amperes} \end{aligned}$$

$$\begin{aligned} \text{Total Power (W)} &= V \times I \\ &= 240 \times 1.85 = 444 \text{ watts} \end{aligned}$$

- 7 If a 40 watt fluorescent lamp draws a current of 0.10 ampere. How much voltage will be required to illuminate it?**

$$\text{Lamp power (W)} = 40 \text{ watt}$$

$$\text{Current (I)} = 0.10 \text{ ampere}$$

$$\begin{aligned} \text{Voltage (V)} &= \frac{W}{I} \\ &= \frac{40}{0.1} = 400 \text{ volts} \end{aligned}$$

- 8 Find the cost of running 15 HP motor for 15 days @ 6 hrs per day and the cost of energy is Rs. 3 per unit.**

$$\begin{aligned} \text{Motor power (w)} &= 15 \text{ HP} \\ &= 15 \times 746 = 11,190 \text{ watts} \end{aligned}$$

$$\begin{aligned} \text{Consumption per day} &= 11,190 \times 6 \\ &= 67140 = 67.14 \text{ KWH} \end{aligned}$$

$$\begin{aligned} \text{Consumption for 15 days} &= 67.14 \times 15 \\ &= 1007 \text{ KWH (or) unit} \end{aligned}$$

$$\text{Cost per unit} = \text{Rs. } 3$$

$$\text{Cost for total energy} = 3 \times 1007 = \text{Rs. } 3021$$

Assignment

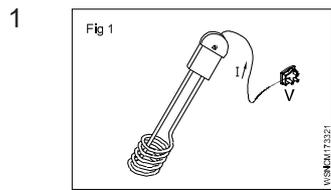

Current Consumed
 $I = 0.136 \text{ A}$
 Voltage 'V' = 220 V
 $P = \underline{\hspace{2cm}}$ Watts

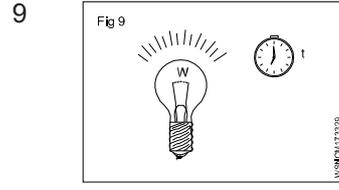

$P = 100 \text{ W}$
 $t = 1 \text{ hour}$
 Energy consumption
 = $\underline{\hspace{2cm}}$ kWh

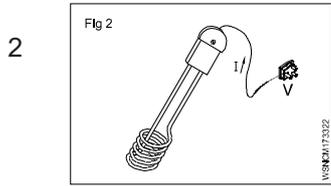

$P = 500 \text{ Watts}$
 $I = 2.27 \text{ A}$
 $V = \underline{\hspace{2cm}}$ v

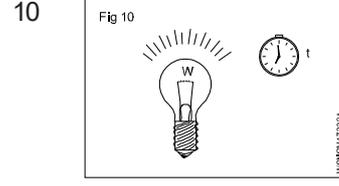

Energy consumed
 'W' = 1 kWh
 Power 'P' = 100 W
 $t = \underline{\hspace{2cm}}$ hr

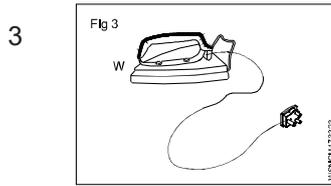

$P = 750 \text{ W}$
 $V = 220 \text{ v}$
 $I = \underline{\hspace{2cm}}$ A

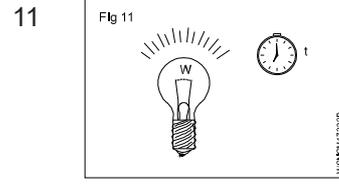

$W = 1.5 \text{ kWh}$
 $t = 45 \text{ min.}$
 $P = \underline{\hspace{2cm}}$ kW.

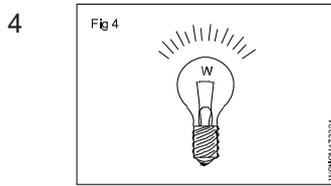

$P = 60 \text{ W}$
 $V = 200 \text{ v}$
 $R = \underline{\hspace{2cm}}$ ohms

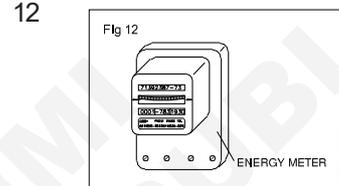

Energy metre reading
 $W_1 = 6755.3 \text{ kWh}$
 Increases to W_2
 = 6759.8 kWh
 $t = 45 \text{ min.}$
 $P = \underline{\hspace{2cm}}$ kW.

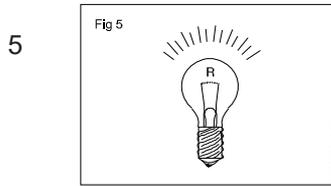

$I = 0.455 \text{ A}$
 $R = 484 \text{ ohms}$
 $P = \underline{\hspace{2cm}}$ Watts

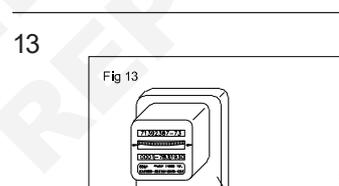

Power consumed
 'P' = 6.2 kW
 $t = 8 \text{ hours}$
 Charge per kwh
 = 1.25 Rupees
 Total cost
 = $\underline{\hspace{2cm}}$ Rupees

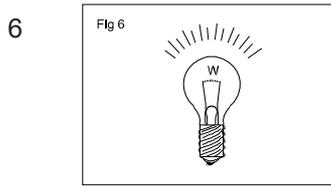

$P = 550 \text{ W}$
 $R = 22 \text{ ohms}$
 $I = \underline{\hspace{2cm}}$ A

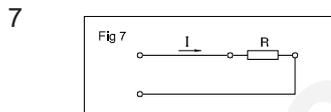

$P \text{ consumed} = 1.8 \text{ kW}$
 $R = 8 \text{ ohms}$
 $V = \underline{\hspace{2cm}}$ v

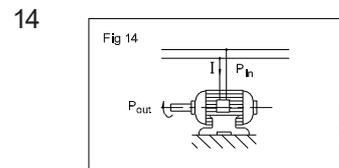

$I = 5.45 \text{ A}$
 $V = 220 \text{ v}$
 Energy consumed
 = 1 kWh
 $t = \underline{\hspace{2cm}}$ hr.

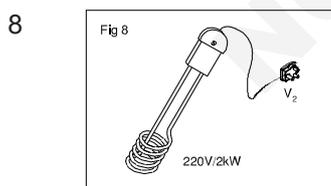

$I \text{ consumed} = \underline{\hspace{2cm}}$ A
 $P = 2 \text{ kW}$
 $V_1 = 220 \text{ V}$ (Heating
 element voltage)
 $R = \underline{\hspace{2cm}}$

Mensuration - Area and perimeter of square, rectangle and parallelogram

In Engineering field, an Engineer has to estimate the material, manpower, machinery, etc. required to prepare the geometrical objects. Hence we must be very conversant with all relevant formulae connected with geometrical objects.

- Length - l unit
- Breadth or width - b unit
- Diagonal - d unit
- Diameter - d unit

- Radius - r unit
- Semi perimeter - S unit
- Perimeter - P unit
- Circumference - C unit
- Area - A unit²
- Total surface area - T.S.A unit²
- Lateral surface area - L.S.A unit²
- Volume - V unit³

Square

This is also a four sided figure, opposite sides are parallel. All the four sides are equal. Angle between adjacent side are 90°.

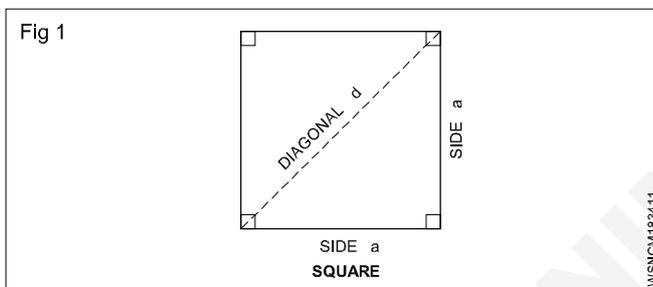

$$A = a^2 \text{ (or) unit}^2$$

$$P = 4a \text{ unit}$$

$$d = \sqrt{2} a \text{ unit}$$

$$a = \frac{d}{\sqrt{2}} \text{ unit where } \sqrt{2} = 1.414$$

Find the area of a brass sheet in the form of a square whose perimeter is 31.2 cm.

$$\text{Perimeter}(P) = 4a = 31.2 \text{ cm}$$

$$\therefore a = \frac{31.2}{4} = 7.8 \text{ cm}$$

$$\text{Area}(A) = a^2$$

$$= 7.8 \times 7.8 = 60.84 \text{ cm}^2$$

Examples

1 Find out the circumference, diagonal and area of a square, whose side is 18 cm.

$$\text{Side of the square (a)} = 18 \text{ cm}$$

$$\text{Perimeter (P)} = 4a$$

$$= 4 \times 18 = 72 \text{ cm}$$

$$\text{Diagonal (d)} = \sqrt{2} \times a$$

$$= \sqrt{2} \times 18 = 1.414 \times 18$$

$$= 25.45 \text{ cm}$$

$$\text{Area (A)} = a^2$$

$$= 18 \times 18 = 324 \text{ cm}^2$$

Perimeter of square = 72 cm

Diagonal = 25.45 cm ; Area = 324 cm²

2 If the diagonal of a square measure 10 cm. Find area of the square.

$$\text{Diagonal of the square (d)} = \sqrt{2} a = 10 \text{ cm}$$

$$\text{Side (a)} = \frac{d}{\sqrt{2}}$$

$$\text{Area}(a^2) = \frac{d}{\sqrt{2}} \times \frac{d}{\sqrt{2}} = \frac{d^2}{2}$$

$$= \frac{10^2}{2} = \frac{100}{2}$$

$$= 50 \text{ cm}^2$$

Area of the square = 50 cm²

3 The perimeter of one square is 748 cm and that of Another is 336 cm. Find the total area of the two squares.

$$\text{Side of the square (a)} = \frac{\text{Perimeter}}{4}$$

1st square

$$\text{Side (a)} = \frac{\text{Perimeter of 1st square}}{4}$$

$$= \frac{748}{4} = 187 \text{ cm}$$

Area (A)

$$= a^2$$

$$= 187 \times 187$$

$$= 34,969 \text{ cm}^2$$

2nd square

$$\text{Side (a)} = \frac{\text{Perimeter of 2nd square}}{4}$$

$$= \frac{336}{4} = 84 \text{ cm}$$

$$\begin{aligned} \text{Area (A)} &= a^2 \\ &= 84 \times 84 \\ &= 7,056 \text{ cm}^2 \end{aligned}$$

$$\begin{aligned} \text{Total area of two squares} &= 34,969 + 7,056 \\ &= 42,025 \text{ cm}^2 \end{aligned}$$

Assignment

- Find the Area, Perimeter and diagonal of a square steel plate whose side measures 28.1 cm.
- Find the area of a square whose diagonal is equal to 8.5 cm.
- Find the area of the square if the side of the square is 28 cm.
- Find its side if the area of the square field is 169 m².
- Find the area of the square if the diagonal of the square is 20 cm.
- Find the perimeter of a square whose diagonal is 144 m.
- Find the area if the perimeter of a square plot is 48 m.

Rectangle

This is a four sided figure. Opposite sides are parallel. Angles between adjacent sides are 90°.

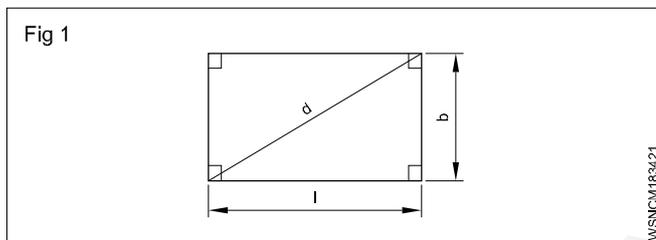

$$A = \text{Area} = \text{length} \times \text{breadth} = l \cdot b \cdot \text{unit}^2$$

$$P = \text{Perimeter} = 2(l + b) \text{ unit}$$

$$\text{Diagonal} = \sqrt{l^2 + b^2} \text{ unit}$$

Examples

- Find the Area, Perimeter and diagonal of a rectangle whose length and breadth are 144 mm and 60 mm respectively.

$$\begin{aligned} \text{Area} = A &= l \times b \text{ unit}^2 \\ &= 144 \times 60 = 8640 \text{ mm}^2 \end{aligned}$$

$$\begin{aligned} \text{Perimeter} = P &= 2(l + b) \text{ unit} \\ &= 2(144 + 60) \\ &= 2 \times 204 = 408 \text{ mm} \end{aligned}$$

$$\begin{aligned} \text{Diagonal} = d &= \sqrt{l^2 + b^2} \text{ unit} \\ &= \sqrt{144^2 + 60^2} \\ &= \sqrt{20736 + 3600} \\ &= \sqrt{24336} = 156 \text{ mm} \end{aligned}$$

- The perimeter of a rectangle is equal to 42 cm. If its breadth is 9 cm. Find the length of the rectangle.

$$\text{Perimeter} = 42 \text{ cm}$$

$$\text{Breath} = 9 \text{ cm}$$

$$\text{Length} = ?$$

$$\text{Perimeter} = P = 2(l + b)$$

$$2(l + 9) = 42$$

$$l + 9 = 42 \div 2$$

$$l + 9 = 21$$

$$l = 21 - 9$$

$$l = 12 \text{ cm}$$

- The perimeter of a rectangle is 48 cm and its length is 4 cm more than its width. Find the length and breadth of the rectangle.

$$\text{Perimeter (P)} = 48 \text{ cm}$$

$$\text{Breath (b)} = x$$

$$\text{Length (l)} = x + 4$$

$$2(l + b) = \text{Perimeter}$$

$$2(x + 4 + x) = 48$$

$$2(2x + 4) = 48$$

$$4x + 8 = 48$$

$$4x = 48 - 8$$

$$x = \frac{40}{4} = 10$$

$$x = \text{breadth} = 10 \text{ cm}$$

$$\text{length} = x + 4 = 10 + 4 = 14 \text{ cm}$$

- 4 How many rectangular pieces of 50 cm x 20 cm can be cut out from a sheet of 1000 cm x 500 cm.

Sheet size = 1000 cm x 500 cm

Size of the rectangular piece to be cut = 50 cm x 20 cm

$$\text{No. of pieces to be cut in lengthwise} = \frac{1000}{50} = 20$$

$$\text{No. of pieces to be cut in breadthwise} = \frac{500}{20} = 25$$

$$\begin{aligned} \text{Total no. of pieces to be cut out} &= 20 \times 25 \\ &= \mathbf{500} \end{aligned}$$

- 5 The perimeter of a rectangle is 320 metre. Its sides are in the ratio of 5:3. Find the area of the rectangle.

$$\text{Ratio} = 5:3 = l : b$$

$$\text{length } l = 5x$$

$$\text{breadth } b = 3x$$

$$2(l + b) = \text{Perimeter}$$

$$2(5x + 3x) = 320$$

$$2(8x) = 320$$

$$16x = 320$$

$$x = \frac{320}{16} = 20$$

$$l = 5x = 5 \times 20 = 100 \text{ m}$$

$$b = 3x = 3 \times 20 = 60 \text{ m}$$

$$\begin{aligned} \text{Area} &= l \times b \quad (\text{length} = 100\text{m, breath} = 60\text{m}) \\ &= 100 \times 60 \end{aligned}$$

$$\text{Area} = 6000 \text{ m}^2$$

Assignment

- Find the area of a rectangular plot whose sides are 24 metres and 20 metres respectively. Also find the perimeter of the plot.
- How many rectangular pieces of 5 cm x 4 cm will you get out of 65 cm x 30 cm brass sheet?
- Find its breadth and area if the perimeter of a rectangle is 400 metre and its length is 140 m.
- Find its area, if the opposite sides of a rectangle are 64 cm and 25 cm respectively.
- What is the width of the rectangle if a rectangle has an area of 224 cm² and length 16 cm.
- What is the length of the diagonal of a rectangle with sides 16 cm and 12 cm?
- Find the area of the rectangle if the perimeter of the rectangle is 100 cm and the ratio of its length and breadth is 3:2.

Parallelogram

This is also a four sided figure, opposite side being parallel to each other.

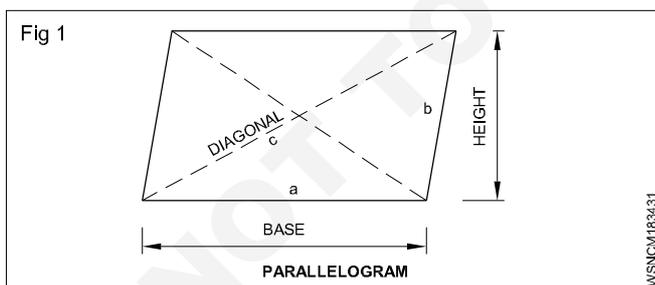

Area of parallelogram = base x height

$$\text{or} = 2x\sqrt{s(s-a)(s-b)(s-c)}$$

Where

$$s = \frac{a+b+c}{2}$$

a and b are adjacent sides.

$$P = 2(a+b)$$

Examples

- 1 The base and height of a parallelogram are 7.1 cm and 2.85 cm. Calculate its area.

$$\begin{aligned} A &= \text{base} \times \text{height units}^2 \\ &= 7.1 \times 2.85 \\ &= \mathbf{20.235 \text{ cm}^2} \end{aligned}$$

- 2 Find the height of a parallelogram whose area is 20 cm² and base is 10 cm.

$$\begin{aligned} A &= \text{base} \times \text{height units}^2 \\ h &= \frac{\text{area}}{\text{base}} \\ &= \frac{20}{10} \\ &= \mathbf{2 \text{ cm}} \end{aligned}$$

3. Two sides of a parallelogram are 12 cm and 8 cm. The diagonal is 10 cm long. Find the area of the parallelogram.

$$\begin{aligned} \text{Area } A &= 2x\sqrt{s(s-a)(s-b)(s-c)} \text{ units}^2 \\ s &= \frac{a+b+c}{2} \\ &= \frac{12+8+10}{2} \\ &= \frac{30}{2} \\ &= 15 \end{aligned}$$

$$\begin{aligned} A &= 2x\sqrt{15(15-12)(15-8)(15-10)} \\ &= 2x\sqrt{15 \times 3 \times 7 \times 5} \\ &= 2x\sqrt{1575} \\ &= 2 \times 39.686 \end{aligned}$$

$$\text{Area } A = 79.37 \text{ cm}^2$$

Assignment

- Find the area of a parallelogram, if its base and height are 8.1 cm and 30.8 cm respectively.
- Find the area of a parallelogram, if the sides of a field in the shape of parallelogram are 12 m and 17 m and one of the diagonal is 25 m.
- Find the base of a parallelogram whose height is 12 cm and area is 120 cm².
- Find the height of a parallelogram whose base is 40 cm and area is 320 cm².
- Find the area of the land if the sides of a land in the shape of a parallelogram are 24 m and 28 m respectively and one of the diagonal is 30 m.
- What is the perimeter of parallelogram if base is 10 cm and other side is 5 cm?
- Find the area of parallelogram if its base and height are 25 cm and 12 cm.
- Find the base of a parallelogram if height is 15 cm and area is 150 cm².
- Find the height of a parallelogram if base is 80 cm and area is 640 cm².
- Find the area of parallelogram if its base and height are 15 cm and 8 cm.
- Calculate the perimeter and area of parallelogram if base, height are 12.7 cm, 5.5 cm and other side is 6.5 cm.
- Find the height of parallelogram if the area is 20 cm² and base is 10 cm.

Mensuration - Area and perimeter of triangles

Triangles

Tri means three. Hence tri- angle means three angled figure. For construction of three angled figure, there should be three sides. Hence triangle means three sided figure. Sum of the three angles of any triangle = 180°.

i Any triangle.

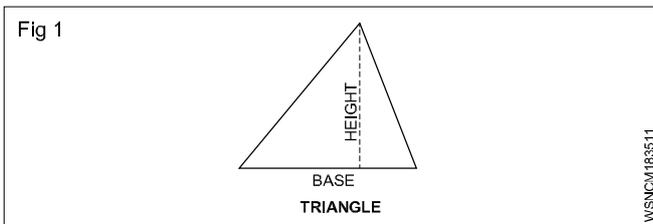

Area of any triangle = $\frac{1}{2}$ x Base x Height unit²

ii Isosceles Triangle

In this triangle two of its sides are equal.

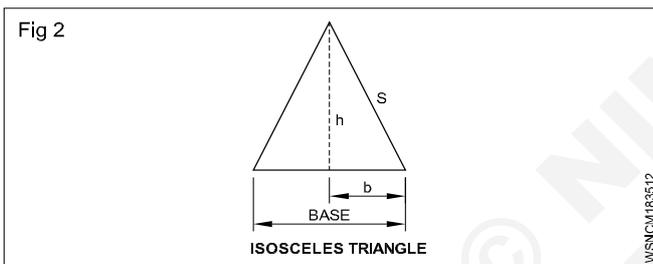

Area of isosceles triangle = $\frac{1}{2}$ x Base x Height

Where

base = 2.b

s = One of equal sides (or) Slant height

h = Height = $\sqrt{s^2 - b^2}$

Area of isosceles triangle = $\frac{1}{2}$ x 2b x $\sqrt{s^2 - b^2}$

= b . $\sqrt{s^2 - b^2}$ unit²

(Where b= half of base)

(or) Area of Isosceles triangle = $\frac{1}{4}$ b $\sqrt{4a^2 - b^2}$ unit²

a = Equal sides

b = Base

iii Equilateral triangle

In this triangle all the three sides are equal. Hence angle between adjacent sides is 60° (Three angles total = 180°)

angle between sides = $\frac{180}{3} = 60^\circ$

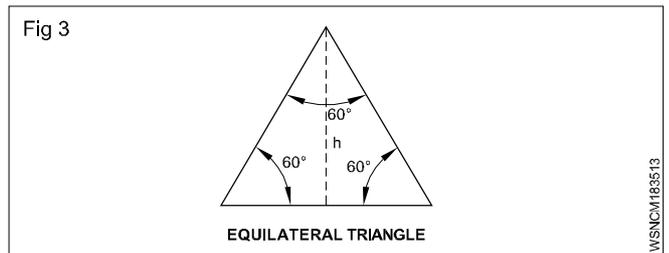

Area of equilateral triangle = $\frac{\sqrt{3}}{4}$ x side²

= $\frac{\sqrt{3}}{4}$ x a² unit²

Where $\sqrt{3} = 1.732$

Perimeter P = 3a unit

P = $\frac{\sqrt{3}}{2}$ a unit

iv Scalene triangle

In this triangle the sides are not equal. Angles between the sides, are also not equal. we may also call this triangle as irregular triangle.

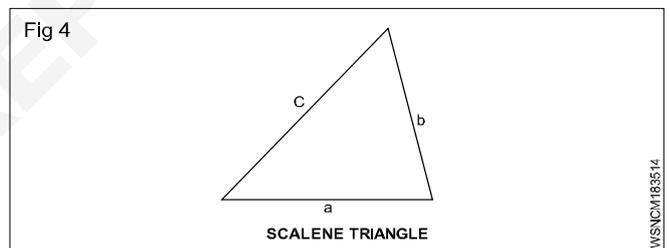

Area of triangle = $\sqrt{s(s-a)(s-b)(s-c)}$ unit²

where

a,b,c are sides of triangle

s = Semi perimeter = $\frac{a+b+c}{2}$ unit

v Right angled triangle

In this triangle, angle between one of two adjacent sides is 90°. Right angle means 90°. That's why right angled triangle means, one of the angles of this triangle is definitely 90°.

Area of right angled triangle

= $\frac{1}{2}$ x Base x Height

= $\frac{1}{2}$ bh unit²

Hypotenuse = $\sqrt{\text{Base}^2 + \text{Height}^2}$

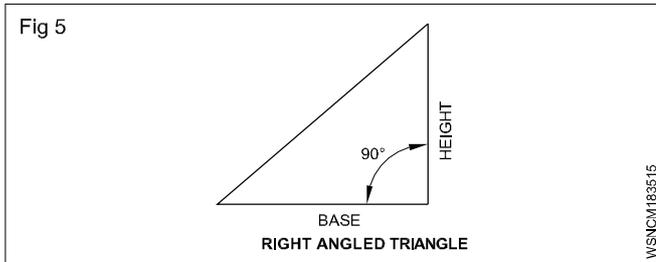

Where hypotenuse means, the diagonal or largest length of the side of right angled triangle.

Examples

- 1 Calculate its area if the base and height of a Right angled triangle are 10 cm and 3.5 cm respectively.

Base (b) = 10 cm

Height (h) = 3.5 cm

Area (A) = ?

$$A = \frac{1}{2} \times b \times h$$

$$= \frac{1}{2} \times 10 \times 3.5$$

$$= 17.5 \text{ cm}^2$$

- 2 Calculate the base of a triangle having an area of 15 cm² and height is 3.5 cm.

Area (A) = 15 cm²

Height (h) = 3.5 cm

Base (b) = ?

$$\frac{1}{2} \times b \times h = A$$

$$\frac{1}{2} \times b \times 3.5 = 15$$

$$b = \frac{15 \times 2}{3.5}$$

$$= 8.57 \text{ cm}$$

- 3 Calculate the height of a triangle whose area is 60 cm² and base is 10 cm.

Area (A) = 60 cm²

Base (b) = 10 cm

Height (h) = ?

$$\frac{1}{2} \times b \times h = A$$

$$\frac{1}{2} \times 10 \times h = 60$$

$$h = \frac{60 \times 2}{10}$$

height h = 12 cm

- 4 Find the area of an isosceles triangle whose base is 6 cm long and each of the other two sides 5 cm long.

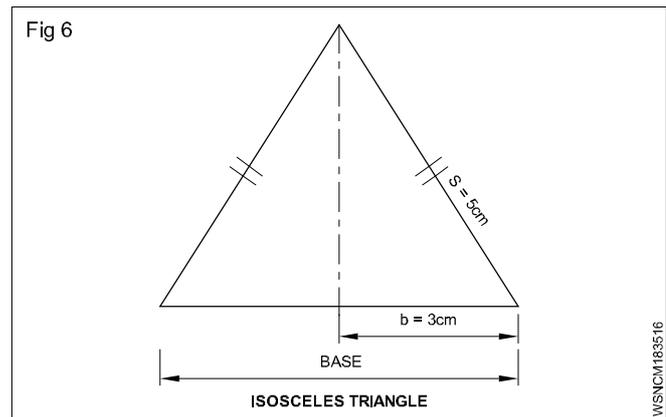

Base (b) = 6 cm = $\frac{6}{2} = 3 \text{ cm}$

Equal sides or slant height 's' = 5 cm

Area (A) = ?

$$A = b \times \sqrt{s^2 - b^2}$$

$$= 3 \times \sqrt{5^2 - 3^2}$$

$$= 3 \times \sqrt{25 - 9}$$

$$= 3 \times \sqrt{16}$$

$$= 3 \times 4$$

$$= 12 \text{ cm}^2$$

or

$$A = \frac{1}{4} b \sqrt{4a^2 - b^2}$$

$$= \frac{1}{4} \times 6 \sqrt{4 \times 5^2 - 6^2}$$

$$= \frac{1}{4} \times 6 \times 8$$

$$= 12 \text{ cm}^2$$

- 5 Find its height if an isosceles triangle has base of 200 mm and its area is 2000 mm².

Base = 200 mm

Area = 2000 mm²

h = ?

$$\frac{1}{2} \times b \times h = A$$

$$\frac{1}{2} \times 200 \times h = 2000$$

$$h = \frac{2000 \times 2}{200} = 20 \text{ mm}$$

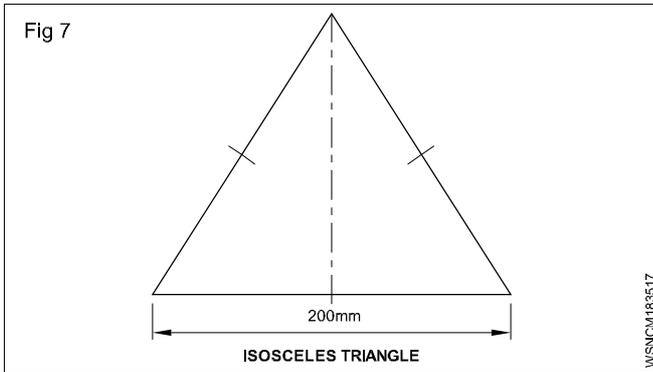

- 6 Find the area of an equilateral triangle whose side is 5 cm.

$$\begin{aligned} \text{Area} &= \frac{\sqrt{3}}{4} a^2 \text{ unit}^2 \\ &= \frac{1.732}{4} \times 5 \times 5 \\ &= \mathbf{10.825 \text{ cm}^2} \end{aligned}$$

- 7 Calculate its perimeter if one side of an equilateral triangle is 55 mm long.

$$\begin{aligned} \text{Side} &= 55 \text{ mm} \\ \text{Perimeter (P)} &= ? \\ P &= 3a \text{ unit} \\ &= 3 \times 55 \\ &= \mathbf{165 \text{ mm}} \end{aligned}$$

- 8 Find the area of the triangle having its sides are 9cm, 10cm and 12 cm.

$$\begin{aligned} \text{Semi Perimeter} &= \frac{a+b+c}{2} \text{ unit} \\ &= \frac{9+10+12}{2} = \frac{31}{2} \\ &= 15.5 \text{ cm} \\ \text{Area A} &= \sqrt{s(s-a)(s-b)(s-c)} \text{ unit}^2 \\ &= \sqrt{15.5(15.5-9)(15.5-10)(15.5-12)} \\ &= \sqrt{15.5 \times 6.5 \times 5.5 \times 3.5} \\ &= \sqrt{1939.4375} \\ &= \mathbf{44.03 \text{ cm}^2} \end{aligned}$$

- 9 Find the cost of polishing on both sides of a triangular metal plate has sides 60 cm, 50 cm and 20 cm at the rate of Rs.1.35 per 100 cm²

$$\text{Semi Perimeter} = \frac{a+b+c}{2} \text{ unit}$$

$$= \frac{60+50+20}{2} = \frac{130}{2}$$

$$= 65 \text{ cm}$$

$$\text{Area A} = \sqrt{s(s-a)(s-b)(s-c)} \text{ unit}^2$$

$$= \sqrt{65(65-60)(65-50)(65-20)}$$

$$= \sqrt{65 \times 5 \times 15 \times 45}$$

$$= \mathbf{468.4 \text{ cm}^2}$$

$$\text{Area of polish on both sides} = 2 \times 468.4$$

$$= 936.8 \text{ cm}^2$$

$$\text{Cost of polish per 100 cm}^2 = \text{Rs. } 1.35$$

$$\therefore \text{Cost of polish is } 936.8 \text{ cm}^2 = \frac{936.8}{100} \times 1.35$$

$$= \text{Rs. } 12.65$$

- 10 Find the area of the right angled triangle with base 20 cm and height 8 cm.

$$\text{Base } b = 20 \text{ cm}$$

$$\text{Equal sides or slant height} = 8 \text{ cm}$$

$$\text{Area (A)} = ?$$

$$\text{Area (A)} = \frac{1}{2} \times \text{base} \times \text{height unit}^2$$

$$= \frac{1}{2} \times 20 \times 8$$

$$= \mathbf{80 \text{ cm}^2}$$

- 11 Find the area of the right angled triangle if the sides containing the right angle being 10.5 cm and 8.2 cm.

$$\text{Area (A)} = \frac{1}{2} \times \text{base} \times \text{height unit}^2$$

$$= \frac{1}{2} \times 10.5 \times 8.2$$

$$= \mathbf{43.05 \text{ cm}^2}$$

- 12 Calculate the perpendicular height of the triangle if the area of the right angled triangle is 19.44 m² and its one of the adjacent side containing the right angle being 5.4 m.

$$\frac{1}{2} \times \text{base} \times \text{height unit}^2 = \text{Area}$$

$$\frac{1}{2} \times 5.4 \times h = 19.44$$

$$h = \frac{19.44 \times 2}{5.4}$$

$$= 7.2 \text{ m}$$

13 Calculate the base of a right angled triangle having an area of 12.5 cm². If its height is 2.5 cm.

$$\frac{1}{2} \times \text{base} \times \text{height unit}^2 = \text{Area}$$

$$\frac{1}{2} \times b \times 2.5 = 12.5$$

$$b = \frac{12.5 \times 2}{2.5}$$

$$= 10 \text{ cm}$$

Pythagoras theorem

In a right angled triangle the area of the square drawn with the hypotenuse as the side is equal to the sum of the areas of the squares drawn with the other two sides.

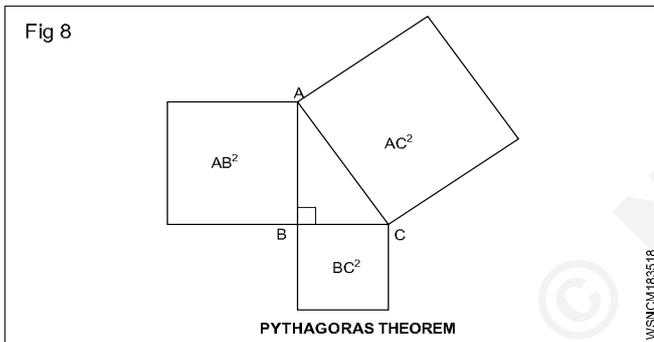

$$\angle B = 90^\circ$$

AC = Hypotenuse

AB & BC = Adjacent sides

As per pythagoras theorem,

$$AC^2 = AB^2 + BC^2$$

$$\therefore AC = \sqrt{AB^2 + BC^2}$$

1 Calculate the hypotenuse of a right angled triangle whose base is 5 cm and height is 12 cm.

As per pythagoras theorem,

$$AC^2 = AB^2 + BC^2$$

$$= 12^2 + 5^2$$

$$= 144 + 25$$

$$= 169$$

$$AC = \sqrt{169}$$

$$= 13 \text{ cm}$$

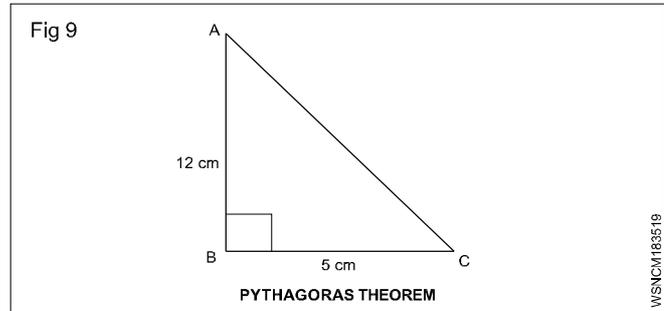

2 What is the length of the hypotenuse of a right angled triangle, when the sides containing the right angles are 10 cm and 12 cm.

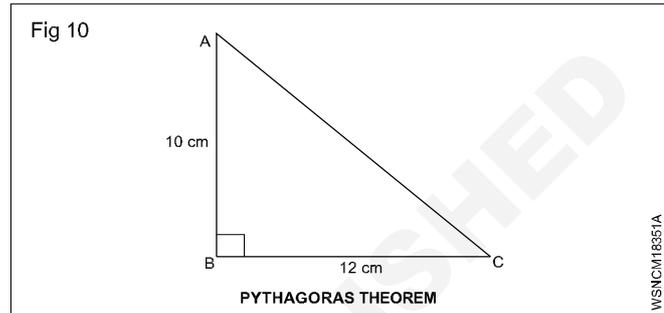

As per pythagoras theorem,

$$AC^2 = AB^2 + BC^2$$

$$= 10^2 + 12^2$$

$$= 100 + 144$$

$$= 244$$

$$AC = \sqrt{244}$$

$$= 15.62 \text{ cm}$$

3 Find the height of a right angled triangle whose base is 15 cm and hypotenuse is 21 cm.

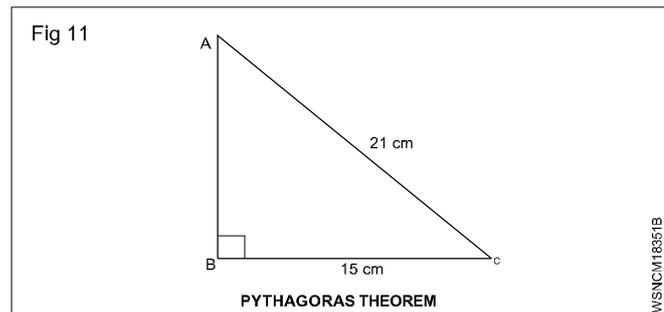

As per pythagoras theorem,

$$AB^2 + BC^2 = AC^2$$

$$AB^2 + 15^2 = 21^2$$

$$AB^2 = 441 - 225$$

$$= 216$$

$$AB = \sqrt{216}$$

$$= 14.7 \text{ cm}$$